



ENDURO-KOTE XL

APPLICATION GUIDELINE

SECTION (07 18 13)

PEDESTRIAN TRAFFIC COATING FOR EXTERIOR GRADE PLYWOOD

PART 1 GENERAL

1.1 SCOPE:

This guideline will provide the necessary instructions and establish uniform procedures for the application of the ENDURO-KOTE XL walking deck/roof covering, to qualify for the limited warranty.

1.2 MODIFICATIONS:

The methods involved may require modification to adjust to job site conditions, air temperature, and weather. Consult Enduro Products for specific design requirements.

1.3 CONDITION OF PLYWOOD SUBSTRATE AND SURFACES:

- 1.31 Verify that work in this Section may be installed in accordance with pertinent codes and regulations, the Contract Documents, referenced standards, and the manufacturer's submittals, as accepted.
- 1.32 All plywood joints must be tightly blocked or tongue and grooved.
- 1.33 Plywood shall be a minimum (19/32) 5/8-inch nominal thick exterior grade.
- 1.34 Verify that the deck will drain properly per local codes. Sloping for drainage shall be a minimum of 1/4-inch per lineal foot.
- 1.35 Verify that the plywood substrate is solid, without damage to the surface, or any soft spots, and that the fastening is installed in accordance with applicable codes, and manufacturers direction.
- 1.36 Surface of the plywood must be dry and clean. Foreign material, that may prevent the bonding of ENDURO-KOTE XL, must be removed.
- 1.37 Bonderized or galvanized sheet metal shall be installed, in accordance with applicable codes, around the perimeter of the area where the ENDURO-KOTE XL will be applied. All joints shall overlap a minimum of two inches and shall be caulked and fastened properly. The horizontal portion of the metal flashing shall extend from the wall a minimum of two inches over the plywood substrate. Where an exterior drip edge occurs, the metal flashing shall extend horizontally a minimum of four inches from the edge over the plywood substrate. All metal flashing, drains, scuppers, vents, etc., shall be bonderized or galvanized sheet metal to facilitate a proper bond of Enduro-Kote.
- 1.38 Verify that the use of plastic drains has been avoided. Use bonderized or galvanized drains only.
- 1.39 Enduro Products, or its Approved Applicators, are not responsible for standing water on the surface of the finished Enduro-Kote XL System. Standing water is normally caused by shrinkage or warping of the plywood substrate.

1.4 JOB SITE CONDITIONS:

- 1.41 Avoid application of ENDURO-KOTE prior to or during moist or inclement weather.
- 1.42 Normal application shall be limited to a temperature range between 50°F and 95°F.
- 1.43 If there are deficiencies in the framing, sheet metal, or any portion of the structure which will affect the application of ENDURO-KOTE XL, the owner or general contractor shall be notified in writing and corrections made before proceeding.

PART 2 QUALIFICATIONS

2.1 APPLICATOR:

Shall be regularly engaged and specializing, (for the preceding 5 years), in the application of similar materials and listed as an approved applicator by Enduro Products Shall be a licensed contractor in the state where work will be performed and approved in writing by Enduro Products.

2.2 SUBMITTALS:

Shall include Enduro-Kote XL sample, submit specifications.

PART 3 MATERIALS

The materials shall be delivered to the job site in the original sealed containers. The label shall bear the product name, manufacturer lot number, and precautionary labels. Applicator shall read and understand all Material Safety Data Sheets prior to using any Enduro-Kote XL materials. All materials listed are manufactured and supplied by Enduro Products.

3.1 EKC CEMENTITIOUS MIX:

Packaged in 46 pound bags.

3.2 EKL ACRYLIC EMULSION:

Packaged in 5 gallon containers.

3.3 ELA BINDER:

Packaged in 5 gallon containers

3.4 EKS ACRYLIC COLOR COAT:

Packaged in 5 gallon containers

3.5 EDC ENDURO-DEK CEMENT:

Packaged in 46lb. bags

3.6 EDS CLEAR ACRYLIC SEALER:

Packaged in 5 gallon containers

PART 4 APPLICATION OF METAL LATH

- 4.1** Shall use minimum of two-and-one-half pound per square yard hot dipped galvanized expanded metal lath. Entire surface of plywood shall be covered with the metal lath from the base of the vertical riser of the wall sheet metal flashing to the gravel stop of the drip edge flashing.
- 4.2** Remove sheets of metal lath from bundle, in same direction, and lay them side by side with the seams butting together. DO NOT OVERLAP. DO NOT place lath seams closer than two inches to a parallel plywood joint. Fasten sheets in place with a few galvanized nails, in the field of the lath, to prevent slipping while stapling.
- 4.3** Use a minimum No. 16 gauge, 7/8-inch crown, 5/8-inch long corrosion-resistant staple. Use a stapling tool capable of countersinking the staple Consult with staple tool manufacturer for correct set up on tool and proper air pressure.
- 4.4** Begin stapling in the middle of the metal lath sheet, using a random pattern, and staple towards the ends until the metal lath is stapled flat to the plywood, using a minimum of 24 staples per square foot. The last row of staples along the edge of the metal lath shall be within one inch of the seam. The seams shall be stapled after the adjacent field of metal lath sheets have been stapled. The seams shall be stapled no more than one inch apart with staples being placed perpendicular to and straddling the seam. The metal lath that overlaps the metal flashing shall be stapled or nailed with galvanized nails no more than one inch apart. Inspect lathing surface prior to application of first coat to insure staples have been installed properly.

PART 5 APPLICATION OF ENDURO-KOTE

5.1 MIXING:

Use a 1/2-inch drill motor, at a speed no greater than 300 RPM, with a mixing tool and mix the EKL Acrylic Emulsion. After mixing, measure one gallon of the EKL Liquid into a five gallon pail. Slowly pour the EKL Cementitious mix, 1/3 bag at a time, into the EKL Liquid while mixing continually. Depending on the air temperature, add up to eight ounces of water to the mixture to obtain proper hydration, and consistency, so the mixture will spread well when it is troweled into the metal lath.

5.2 FIRST COAT:

Start at the edge of the perimeter by the metal flashing and brush the mixture into the metal lath over the metal flashing. Trowel the mixture over the brushed areas, and the field of the metal lath, back and forth into the lath with smooth even strokes to the vertical riser of the flashing, or to the gravel stop of the drip edge sheet metal. **DO NOT FLOAT** the mixture. Use the lath as a screed. Minimum time for air cure is two hours before applying the next coat.

5.3 ENDURO LASTIC:

Roll out .75 oz. per sf chopped strand mat butting edges tightly and apply Enduro-Lastic ELA binder at a rate of 50 sq. ft. per gallon thoroughly saturating fiberglass mat. Apply two coats if necessary to achieve specified coverage rate.

5.4 WEARING COAT:

Mix wearing coat identical to first coat and spread evenly covering the Enduro-Lastic and fiberglass mat.

5.5 PREPARATION FOR FINAL COAT:

Surface must be dry and free of foreign material.

5.6 APPLICATION OF COLOR COAT:

Surface must be dry and free of all foreign material. Mix EKS Color Coat thoroughly with mixing tool, before and during application. Brush color coat into the edges and corners of the flashing, including the riser of flashing. Roll color coat over the texture coat with a 3/4 inch nap roller until uniform coverage is achieved. Under normal conditions, the second coat can be applied when the first coat is dry to the touch.

5.7 APPLICATION OF ENDURO-DEK FINISH COATS:

Refer to Enduro Dek Data Sheet for Enduro-Dek installation Guidelines or consult Enduro Products.

PART 6 PEDESTRIAN TRAFFIC BETWEEN COATS

Light pedestrian traffic (depending on air temperature, humidity, etc.) may be allowed after approximately two hours of cure time for the first coat, second coat, and the color coat. However, the color coat should be given twenty-four hours cure time, before heavy pedestrian traffic is allowed. Pedestrian traffic shall not be allowed on the finished surface until the contractor/owner has given final acceptance and approval of the applicator's work.

PART 7 LIMITED WARRANTY

ENDURO-KOTE XL waterproof products are guaranteed against water penetration for a period of ten years. Failure of contiguous materials or substructure invalidates this warranty. Failure of substructure or materials may be described as follows:

- Failure of substrate plywood, joists or beams.
- Deletion of, or punctured, felt paper behind siding or stucco.
- Failure of sheet metal flashing, drains, or scuppers.

If any contiguous building material should fail causing leaking under the ENDURO-KOTE XL System.

Improper application of ENDURO-KOTE, or deviations from specifications, will invalidate the limited warranty.

Maintenance of the ENDURO-KOTE System is the responsibility of the ultimate user/owner. A copy of the Maintenance Policy and Procedure may be obtained from the manufacturer or Approved Applicator.



Corporate Office: 1133 N. Patt Street, Anaheim, California 92801 • Phone: (714) 526-5898 • Fax: (714) 526-6511
Florida Office: 6301 Porter Road, Suite 12, Sarasota, Florida 34240 • (941) 378-9794 • Fax: (941) 378-9438
Toll Free: (877) 809-0781 • Email: info@endurokote.com • Website: www.endurokote.com



ENDURO-KOTE XL

PRODUCT GUIDE SPECIFICATION

Specifier Notes: This product guide specification is written according to the Construction Specifications Institute (CSI) 3-Part Format, including *MasterFormat*, *SectionFormat*, and *PageFormat*, as described in *The Project Resource Manual – CSI Manual of Practice*.

The section must be carefully reviewed and edited by the Architect to meet the requirements of the project and local building code. Coordinate this section with other specification sections and the Drawings. Delete all “Specifier Notes” when editing this section.

Section numbers are from *MasterFormat* 1995 Edition, with numbers from *MasterFormat* 2004 Edition in parentheses. Delete version not required.

SECTION 07180 (07 18 13)

PEDESTRIAN TRAFFIC COATINGS

Specifier Notes: This section covers Enduro Products “Enduro-Kote XL” walking deck and roof covering. Consult Enduro Products for assistance in editing this section for the specific application.

PART 1 GENERAL

1.1 SECTION INCLUDES

- A. Pedestrian traffic coating applied to plywood substrate.

1.2 RELATED SECTIONS

- A. Section 06160 (06 16 00) – Sheathing.
- B. Section 07620 (07 62 00) – Sheet Metal Flashing and Trim.
- C. Section 07920 (07 92 00) – Joint Sealants.

1.3 REFERENCES

- A. ASTM C 67 – Standard Test Methods for Sampling and Testing Brick and Structural Clay Tile.
- B. ASTM C 109 – Standard Test Method for Compressive Strength of Hydraulic Cement Mortars (Using 2-in. or [50-mm] Cube Specimens).
- C. ASTM C 297 – Standard Test Method for Flatwise Tensile Strength of Sandwich Constructions.
- D. ASTM D 570 – Standard Test Method for Water Absorption of Plastics.
- E. ASTM D 756 – Practice for Determination of Weight and Shape Changes of Plastics Under Accelerated Service Conditions.
- F. ASTM D 1242 – Standard Test Methods for Resistance of Plastic Materials to Abrasion.

Specifier Notes: Edit the following list of related sections as required for the project. List other sections with work directly related to this section.

Specifier Notes: List standards referenced in this section, complete with designations and titles. This article does not require compliance with standards, but is merely a listing of those used.

- G. ASTM D 1499 – Standard Practice for Filtered Open-Flame Carbon-Arc Exposures of Plastics.
- H. ASTM D 2299 – Recommended Practice for Determining Relative Stain Resistance of Plastics.
- I. ASTM E 108 – Standard Test Methods for Fire Tests of Roof Coverings.
- J. ASTM E 119 – Standard Test Methods for Fire Tests of Building Construction and Materials.
- K. ASTM G 152 – Standard Practice for Operating Open Flame Carbon Arc Light Apparatus for Exposure of Nonmetallic Materials.
- L. UL 790 – Standard for Standard Test Methods for Fire Tests of Roof Coverings.

1.4 PERFORMANCE REQUIREMENTS

- A. Performance Requirements: Provide fire-retardant, waterproof, wearing surface for pedestrian traffic. Acceptance Criteria for Walking Decks AC39 and having following cured-state characteristics:
 - 1. Weatherometer Test, ASTM D 1499 and G 152, Model D or H, 2,000 Hours: No crazing, cracking, spalling, softening, or other surface deterioration.
 - 2. Accelerated Aging Test, ASTM D 756, Procedures D and E, 6 Cycles, and Procedures D, E, and F, 25 Cycles: Passed bond strength test.
 - 3. Fire Retardancy, ASTM E 108 and UL 790: Class A rating.
 - 4. One-Hour Fire Resistance, ASTM E 119: One-hour fire-resistive rating, with minimum nominal 2 by 8 joists spaced.
 - 5. Bond Strength, ASTM C 297:
 - a. After Accelerated Aging Test, ASTM D 756, Procedures D and E, 6 Cycles: Average 83 psi minimum.
 - b. After Accelerated Aging Test, ASTM D 756, Procedures D, E, and F, 25 Cycles: Average 82 psi minimum.
 - c. After Freeze Thaw Test, ASTM C 67: Average 104 psi minimum.
 - 6. Abrasion Resistance Test, ASTM D 1242, Method A: Did not exceed maximum loss in thickness allowed.
 - 7. Percolation: No noticeable leakage on each of 5 test specimens.
 - 8. Water Absorption Test, ASTM D 570: 8.7 percent by weight.
 - 9. Chemical Resistance Test, ASTM D 2299:
 - a. Unaffected By: Industrial detergent 20 percent solution, ammonia 5 percent solution, salt 20 percent solution, anti-freeze, kerosene, turpentine, and paint thinner.
 - b. Superficially Affected By: Chlorine 10 percent solution and sulfuric acid 3 percent solution.
 - c. Moderately Affected By: Muriatic acid 10 percent solution.
 - 10. Freeze Thaw Test, ASTM C 67:
 - a. No breakage, weight loss, cracking, crazing, or delamination.
 - b. Passed bond strength test.
 - 11. Concentrated Load, Average Residual Indentation: 0.009 inch.
 - 12. Wind Uplift: Meets requirements for bond strength tests, after accelerated aging and freeze thaw tests.
 - 13. Weight, Includes Pedestrian Traffic Coating, Metal Lath, and Staples: 2.2 pounds per square foot.
 - 14. Compressive Strength Test, ASTM C 109: 5,324 psi.

1.5 SUBMITTALS

- A. Comply with Section 01330 (01 33 00) – Submittal Procedures.
- B. Product Data: Submit manufacturer's product data, including surface preparation and application instructions.
- C. Samples:
 - 1. Submit manufacturer's standard color chart for selection of color.
 - 2. Submit manufacturer's samples of pedestrian traffic coating, minimum 4 inches by 9 inches.
- D. Manufacturer's Certification: Submit manufacturer's certification that materials comply with specified requirements and are suitable for intended application.
- E. Maintenance Instructions: Submit manufacturer's maintenance and cleaning instructions.
- F. Warranty: Submit manufacturer's standard warranty.

1.6 QUALITY ASSURANCE

- A. Manufacturer's Qualifications: Manufacturer regularly engaged, for preceding 10 years, in manufacture of pedestrian traffic coatings of similar physical characteristics to those specified.
- B. Applicator's Qualifications:
 - 1. Applicator regularly engaged, for preceding 5 years, in application of similar materials to those specified.
 - 2. Approved by manufacturer.
- C. Regulatory Requirements:
- D. Pre-application Meeting:
 - 1. Convene pre-application meeting before start of application of pedestrian traffic coating.
 - 2. Require attendance of parties directly affecting work of this section, including Contractor, Architect, and applicator.
 - 3. Review examination, preparation, mixing, application, protection, and coordination with other work.

1.7 DELIVERY, STORAGE, AND HANDLING

- A. Delivery: Deliver materials to site in manufacturer's original, unopened containers and packaging, with labels clearly indicating the following on each container:
 - 1. Product name.
 - 2. Manufacturer.
 - 3. Material batch or lot number.
- B. Storage: Store materials in clean, dry area indoors, off ground, in accordance with manufacturer's instructions.
- C. Handling: Protect materials during handling and application to prevent contamination or damage.

1.8 ENVIRONMENTAL REQUIREMENTS

- A. When applying pedestrian traffic coating at air temperatures below 50 degrees F or above 95 degrees F, contact manufacturer regarding additives to be added in mixing liquids.
- B. Do not apply pedestrian traffic coating for 24 hours before or during rainy weather.

1.9 WARRANTY

- A. Warranty Period:
 - 1. Against Water Penetration: 10 years from date of installation.
 - 2. Workmanship: 2 years from date of installation, including removal and repair or replacement of material which becomes defective within warranty period.

Specifier Notes: Edit pre-application meeting as required for the project.

PART 2 PRODUCTS

2.1 MANUFACTURER

- A. Enduro Products, 1133 Patt Street, Anaheim, California 92801.
Phone: (714) 526-5898 • Fax: (714) 526-6511 • Website: www.endurokote.com • Email: info@endurokote.com.

2.2 PEDESTRIAN TRAFFIC COATINGS

- A. Pedestrian Traffic Coating: Enduro-Kote XL walking deck and roof covering.
 - 1. Cementitious Powder: EKC Powder.
 - 2. Acrylic Emulsion: EKL Liquid.
 - 3. Elastomeric Binder.
 - 4. Chopped Strand Fiberglass Mat
 - 5. Acrylic Color Coat: EKS Color Coat.

2.3 ACCESSORIES

- A. Metal Lath: Hot-dipped galvanized steel, expanded metal lath, minimum 2-1/2 pounds per square yard.
- B. Staples: Corrosion-resistant steel, minimum No. 16 gage, 7/8-inch or 1-inch crown, 5/8-inch long.
- C. Fiberglass Mat: .75 Oz. per s.y. chopped strand fiberglass mat.

PART 3 EXECUTION

3.1 EXAMINATION

- A. Examine areas to receive pedestrian traffic coating.
 - 1. Verify deck will drain properly, without low spots or high fascia edges.
 - 2. Verify exterior-grade plywood substrate is as specified in Section 06160 (06 16 00).
 - 3. Verify plywood is clean, dry, and solid, without damage to surface or soft spots.
 - 4. Verify plywood fastening is as specified.
 - 5. Verify plywood joints are tongue and grooved or tightly blocked.
 - 6. Verify bonderized, galvanized sheet metal flashing at perimeter is as specified in Section 07620 (07 62 00), with joints and seams caulked as specified in Section 07920 (07 92 00).
 - 7. Verify plastic drains are not used.
- B. Notify Architect of conditions that would adversely affect application or subsequent use.
- C. Do not begin surface preparation or application until unacceptable conditions are corrected.

3.2 PREPARATION

- A. Protection: Protect adjacent surfaces from contact with pedestrian traffic coating.
- B. Prepare surfaces to receive pedestrian traffic coating in accordance with manufacturer's instructions.
- C. Remove dirt, dust, debris, oil, grease, and other surface contaminants which could adversely affect application of pedestrian traffic coating.
- D. Sweep plywood surface and joints clean and free of dirt and dust before application of pedestrian traffic coating.

3.3 MIXING

- A. Mix materials in accordance with manufacturer's instructions.

3.4 APPLICATION

- A. Apply pedestrian traffic coating in accordance with manufacturer's instructions at locations indicated on the Drawings.
- B. Metal Lath:
 - 1. Attach metal lath to plywood substrate with a minimum of 24 staples per square foot, uniformly spaced.
 - 2. Do not overlap metal lath.
 - 3. Splice butt joints with staples spaced a maximum of 1 inch apart.
 - 4. Lap metal flashing to base of vertical risers and deck drains.
- C. Pedestrian Traffic Coating:
 - 1. First Coat:
 - a. Trowel mixture into metal lath ensuring voids in lath are filled.
 - b. Minimum Thickness: 1/8 inch.
 - 2. Endurolastic Binder and chopped strand fiberglass mat:
 - a. Apply Endurolastic Binder at 50 s.f. per gallon over tightly butted fiberglass mat.
 - 3. Wearing Coat:
 - a. Trowel Enduro-Kote mixture ensuring even coverage over Enduro-Lastic/Fiberglass.

4. Final Coat:
 - a. Apply EKS Color Sealer or Enduro-Dek Decorative Finish over Wearing Coat Architect.
 - b. Apply smooth or decorative finish coat over second coat to achieve finish coat equal to samples accepted by Architect. Smooth coat shall meet standards for non-skid surface.
 - c. Minimum Thickness: 1/16 inch.
5. Color Coat: Apply 2 uniform coats of color coat over finish coat.
6. Minimum Thickness of Completed Pedestrian Traffic Coating: 3/16-inch.

3.5 PROTECTION

- A. Protect completed pedestrian traffic coating from pedestrian traffic for a minimum of 24 hours after application of color coat.
- B. Protect completed pedestrian traffic coating from damage during construction and from continuous contact with solvents.

Specifier Notes: Specify texture, smooth, or decorative finish.



Corporate Office: 1133 Patt Street, Anaheim, California 92801 • Phone: (714) 526-5898 • Fax: (714) 526-6511
Florida Office: 6301 Porter Road, Suite 12, Sarasota, Florida 34240 • (941) 378-9794 • Fax: (941) 378-9438
Toll Free: (877) 809-0781 • Email: info@endurokote.com • Website: www.endurokote.com



ENDURO PRODUCTS

Technical Data Sheet

ENDURO-KOTE Cement

1. Description:

EP ENDURO-KOTE Cement is a two component premixed uniform blend of portland cements and graded washed silica aggregates with a liquid polymer modifier. Suitable for interior or exterior use, this waterproof topping compound can be used for renovation and new construction. The system components are ENDURO-KOTE Cementitious Mix (EKC) and ENDURO-KOTE Emulsion (EKL).

2. Uses:

EP ENDURO-KOTE Cement is designed for use on the following: As a class "A" waterproof traffic coating for roofs and exterior decks, and as a wearing surface for the EP ENDURO-KOTE XL, EP ENDURO-FLEXKOTE and EP ENDURO-LASTIC Traffic Coating Systems. EP ENDURO-KOTE Cement may also be used to repair concrete slabs, parking decks, and for leveling or creating pitch to drains.

3. Surface Preparation:

All substrates to receive EP ENDURO-KOTE Cement should be of sound structural grade, clean and free of dust, oil, grease, sealers, curing compounds, laitance, release agents or other surface contaminants. For best results, apply mechanical abrasion by bead blast or mechanical grinding of the concrete surface. Remove any loose dust or dirt by vacuum cleaning. The cleaning and preparation method selected depends on both the substrate and its condition. When applying as part of the EP ENDURO-KOTE, EP ENDURO-FLEXKOTE or EP ENDURO-LASTIC Traffic Coating Systems follow the application procedure as laid out in each respective application guideline. Concrete should be completely dry to promote optimum adhesion. Consult Enduro Products regarding methods for checking moisture content of concrete. When EP ENDURO-KOTE Cement is to be applied on surfaces other than concrete (i.e., wood, metal, terrazzo, gypsum underlayments, etc.), consult

Enduro Products for recommended preparation.

4. Mixing:

Mix EP ENDURO-KOTE Cement is mixed by adding the ENDURO-KOTE Emulsion (EKL) at a rate of approximately 1-gallon for each 46-lb. bag of ENDURO-KOTE Cementitious Mix (EKC). The EKL polymer should be added to the mixing container first, then the EKC Powder. Use a mortar mixing paddle with a low speed drill (400-500 rpm) to mix thoroughly until the cementitious mix has a smooth homogeneous texture. Do not add any EKL polymer after the EP ENDURO-KOTE Cement has started setting up. The pot life per batch is approximately 15 to 20 minutes depending on the temperature.

5. Packaging:

EP ENDURO-KOTE Cement components are available as follows: ENDURO-KOTE Cementitious Mix (EKC) in 46-lb. bags and ENDURO-KOTE Emulsion (EKL) in 1 gallon containers and 5 gallon pails.

6. Application:

Apply EP ENDURO-KOTE Cement with a trowel or straight edge, trowel to desired texture, on the prepared surface. EP ENDURO-KOTE Cement may also be used to create a knock down splatter texture. Should a broom finish be desired, do so after placement. Do not add or spray polymer onto the surface for finishing, it may cause the surface to spall. Rough spots or trowel marks may be sanded off the surface, using a medium to fine grit sandpaper after the EP ENDURO-KOTE Cement has setup. Sanding should be accomplished no later than 24 hours after application. Allow an adequate curing time before applying a sealer, by using a latex or a water based concrete sealer (surface or penetrating). When EP ENDURO-KOTE Cement is going to be a wearing surface, a sealer or coating is recommended.

7. Coverage:

Refer to the application guideline for EP ENDURO-KOTE XL, EP ENDURO-FLEXKOTE, and EP ENDURO UT for specific coverage rates when EP ENDURO-KOTE Cement is used as a traffic coating.

8. Limitations:

Avoid application prior to or during moist or inclement weather. Normal application shall be limited to a temperature range of 50 to 95 degrees Fahrenheit. Plastic drains are to be avoided. Do not allow any of the Enduro Products to freeze.

9. Cleaning Instructions:

Uncured material can be removed with soap and water. If cured, material can only be removed mechanically. Clean up tools and equipment with soap and water after use.

10. Safety Health and Environmental Recommendations:

Provide proper ventilation. Avoid coating contact with skin and eyes. Use protective goggles and clothing. In case of eye contact, flood eyes with water and call a physician immediately. Wash

hands thoroughly with soap and water after handling. Do not take internally. If ingested, call a physician immediately. Read the Material and Safety Data Sheet for EP ENDURO-KOTE Cement prior to handling or application as supplied by Enduro Products in California: (714) 526-5898, Fax (714) 526-6511; in Florida: (305) 591-8309, Fax (305) 591-8565; email: info@endurokote.com.

11. Warranty:

Enduro Products warrants its EP ENDURO-KOTE Cement to be free of defects in materials, but makes no warranty as to appearance or color. Since methods of application and on-site conditions are beyond our control and can affect performance, Enduro Products makes no other warranty, expressed or implied, including warranties of merchantability and fitness for a particular purpose with respect for Enduro Products. Enduro Products' sole obligation shall be, at its option, to replace or to refund the purchase price of the quantity of EP ENDURO-KOTE Cement proven to be defective and Enduro Products shall not be liable for any loss or damage.

Technical Data

TEST	REFERENCE	RESULTS
Compression Strength	ASTM C109	5,325 psi
Abrasion Resistance	ASTM D 1242, Method A	Did not exceed maximum loss in thickness allowed
Water Absorption	ASTM D 570	8.7 percent by weight
Accelerated Aging	ASTM D 756, Procedures D & E, 6 Cycles	Passed bond strength test
Bond Strength (after)	ASTM C 297	Average 83 psi minimum
Accelerated Aging	Procedures D, E, & F, 25 Cycles	Passed bond strength test
Bond Strength (after)	ASTM C 297	Average 82 psi minimum
Freeze Thaw	ASTM C 67	No breakage, weight loss, cracking, crazing, or delamination
Bond Strength (after)	ASTM C 67	Average 104 psi minimum





ENDURO PRODUCTS

Technical Data Sheet

ENDURO-KOTE EKS Pedestrian Deck Coating

1. Description:

EP ENDURO-KOTE EKS Pedestrian Deck Coating is a high performance epoxy-fortified acrylic coating designed for interior and exterior use. It is a durable, abrasion resistant, fluid applied coating for pedestrian surfaces.

2. Uses:

EP ENDURO-KOTE EKS Pedestrian Deck Coating is designed for interior or exterior use on new or existing concrete, plywood or asphalt surfaces.

3. Surface Preparation:

3.1 Concrete: All concrete surfaces to receive EP ENDURO-KOTE EKS Pedestrian Deck Coating should be of sound structural grade. For best results, apply mechanical abrasion by bead or sandblast to the concrete surface. Follow with acid etching using a diluted solution of muriatic or phosphoric acid. Caution: Acids are dangerous if handled improperly. Follow acid label precautions carefully and dispose properly. If the concrete is extremely smooth, the etching process may require repeating. Follow the acid etching with a thorough TSP or other detergent cleaning and rinse with generous amounts of water. After drying, remove any loose dust or dirt by vacuum cleaning or further rinsing. Test for porosity prior to paint application. Concrete should be completely dry to promote optimum adhesion. To check for moisture in the concrete, follow ASTM 6263. All concrete surfaces must be clean, dry, and free of all foreign matter such as dirt, dust, oil mildew or other contaminants. Repair cracks and holes in the surface to be coated with appropriate patching materials.

3.2 Plywood: All plywood surfaces should be selected and installed in accordance with the requirements of the applicable building code. All contaminants and imperfections that may impair adhesion must be removed. Glossy or slick surfaces must be scuff sanded prior to coating.

All new plywood surfaces must be primed.

3.2 Asphalt: All asphalt surfaces must be clean, dry, and free of all foreign matter such as dirt, dust, oil mildew or other contaminants. The surface must be structurally sound. Repair cracks and holes in the surface to be coated with appropriate patching materials.

4. Mixing & Priming:

EP ENDURO-KOTE EKS Pedestrian Deck Coating should be used at package consistency. If thinning is required, use water sparingly. New plywood should be primed with EN-70 Primer which is a two part epoxy primer. Stir Part A. Stir Part B. Mix all of Part A with all of Part B for 2 to 3 minutes. The mixed primer should stay in the mixing container for 30 minutes before use. Prime substrate at a rate of 250-300 square feet per gallon with EN-70 Primer. Allow primer to dry until it is tack-free for a minimum of one hour and no more than eight hours before the application of EP ENDURO-KOTE EKS Pedestrian Deck Coating.

5. Color/Finish Packaging:

Consult the Enduro Products Pedestrian Deck Coating Color Chart for available colors. EP ENDURO-KOTE EKS Pedestrian Deck Coating is available in a low sheen finish (sheen @ 85% = 4.0 - 4.4%). Anti-slip coating is a special order. Coating is available in one-gallon and five-gallon containers.

6. Application:

Apply EP ENDURO-KOTE EKS Pedestrian Deck Coating in two (2) coats to achieve proper dry film thickness with a brush or roller. The coating should be applied at full package consistency. The first coat on concrete may be thinned up to 10% with water. Allow 2-4 hours between coats of EP ENDURO-KOTE EKS Pedestrian Deck Coating and 30 minutes to

touch. The coating will be fully cured in 24 hours for normal traffic and 72 hours for heavy traffic. Drying time depends on temperatures and humidity.

7. Coverage:

Coverage will vary depending on the condition of the surface and the texture desired to achieve proper dry film thickness. Average applications will yield the mil thickness as follows: EP ENDURO-KOTE EKS Pedestrian Deck Coating at 200 to 250 square feet per gallon to obtain 6 wet mils/2.6 dry mils; and EP ENDURO-KOTE EKS Pedestrian Deck Coating at 75 to 100 square feet per gallon with aggregate to obtain 12 wet mils.

8. Limitations:

Ambient and surface temperatures must be above 55°F and relative humidity below 80%. Do not apply EP ENDURO-KOTE EKS Pedestrian Deck Coating over any type of lightweight concrete without written approval by Enduro Products. Do not apply to surfaces with excessive moisture content or when there is a threat of rain.

9. Cleaning Instructions:

Clean up tools and equipment with soap and water after use.

10. Safety Health and Environmental Recommendations:

Provide proper ventilation. Avoid coating contact with skin and eyes. Use protective goggles and clothing. In case of eye contact, flood eyes with water and call a physician immediately. Wash hands thoroughly with soap and water after handling. Do not take internally. If ingested, call a physician immediately. Read the Material and Safety Data Sheet for EP ENDURO-KOTE EKS Pedestrian Deck Coating prior to handling or application as supplied by Enduro Products in California: (714) 526-5898, Fax (714) 526-6511; in Florida: (941) 378-9794, Fax (941) 378-9438; email: info@endurokote.com.

11. Warranty:

Enduro Products warrants its EP ENDURO-KOTE EKS Pedestrian Deck Coating to be free of defects in materials, but makes no warranty as to appearance or color. Since methods of application and on-site conditions are beyond our control and can affect performance, Enduro Products makes no other warranty, expressed or implied, including warranties of merchantability and fitness for a particular purpose with respect for Enduro Products. Enduro Products' sole obligation shall be, at its option, to replace or to refund the purchase price of the quantity of EP ENDURO-KOTE EKS Pedestrian Deck Coating proved to be defective and Enduro Products shall not be liable for any loss or damage.

Technical Data

Total Pigment	36.6%
Titanium Dioxide	15.6%
Extenders	21.0%
Total Vehicle	63.4%
Acrylic Resin	21.5%
Additives	5.0%
Water	36.9%
Weights & Measurements	±3.0%
Percent Solids By Weight	59.5%
Percent Solids By Volume	47.1%
Viscosity	98-102 KU
Coating VOC	46 g/l

SCAQMD - complies with SCAQMD Rule 1113
LEED - complies with Green Seal GS - 11
MPI - #60



Corporate Office: 1133 N. Patt Street, Anaheim, California 92801 • Phone: (714) 526-5898 • Fax: (714) 526-6511
Florida Office: 8050 N.W. 66th Street, Miami, Florida 33166 • (305) 591-8309 • Fax: (305) 591-8568
Toll Free: (877) 809-0781 • Email: info@endurokote.com • Website: www.endurokote.com

© EP ENDURO-KOTE EKS Pedestrian Deck Coating

REVISED AUGUST 2017



Safety Data Sheet

Section 1: Identification of the Product/Company

Product Identifier:

Product Name: EKL Emulsion

Product Code:

Relevant identified uses of the substance or mixture

Recommended use:

For professional use in the construction industry

Uses advised against:

None identified

Details of the supplier of the safety data sheet

Manufacturer:

Enduro Products
1133 N. Pratt Street
Anaheim, CA 92801
United States
www.endurokote.com

Telephone (General)

(714) 526-5898

Emergency telephone number

Manufacturer: (714) 526-5898 USA

Section 2: Hazards Identification

Classification of the substance or mixture

GHS-US classification

No need for classification according to GHS criteria for this product

Label elements

GHS-US labeling

The product does not require a hazard warning label in accordance with GHS criteria.

Other hazards

No other information available



Safety Data Sheet

Unknown acute toxicity (GHS-US)

No data available

Section 3: Composition/information on ingredients

Substances

Name	Product Identifier	% by weight	GHS-US classification
Acrylic resin	Trade secret	20-60	

Amounts specified are typical and do not represent a specification. Any other ingredients are either proprietary, non-hazardous or present in amounts below the reportable limits.

Section 4: First aid measures

Description of necessary first aid measures

First-aid measures general:

Remove contaminated clothing

First-aid measures after inhalation:

If affected, remove to fresh air. Assist in breathing if necessary

First-aid measures after skin contact:

Immediately remove contaminated clothing and shoes. Launder clothing before reuse. Seek medical attention if symptoms of irritation or burns occur.

First-aid measures after eye contact:

Flush with copious amount of water for at least 15 minutes. If irritation develops, seek medical attention.

First-aid measures after ingestion:

Do not induce vomiting. Call a physician or poison control center immediately for further instructions. Never give anything by mouth to an unconscious or convulsing person. If person is conscious, rinse out the mouth with water and give plenty of water to drink. Get medical attention immediately.

Most important and effects, both acute and delayed

Symptoms:

None expected due to the non-classification of the product.

Indication of any immediate medical attention and special treatment needed



Safety Data Sheet

Treat symptomatically

Section 5: Firefighting measures

Extinguishing media

Suitable extinguishing media:

Water spray, foam, dry powder

Unsuitable extinguishing media:

None known

Special hazards arising from the substance or mixture

Fire hazard:

Poses no fire related hazard. No particular hazards known

Explosion hazard:

Non-explosive

Reactivity:

Will not facilitate or support combustion of other materials.

Advice for firefighters

Firefighting instructions:

Not required

Protection during firefighting:

Firefighters should be equipped with self-contained breathing apparatus and turn out gear.

Additional information

Section 6: Accidental release measures

Personal precautions, protective equipment and emergency procedures

General measures:

Wear protective equipment as described under Section 8 and follow the advice of safe handling and use given under Section 7. Emergency procedures are not required.

For non-emergency personnel

Protective equipment:

Wear chemical resistance (impervious) gloves

Emergency procedures:

High risk of slipping due to spillage/leakage of product

For emergency responders

Protective equipment:

Not Applicable



Safety Data Sheet

Emergency procedures:

Not Applicable

Environmental precautions

Do not allow to enter drains, sewers or watercourses.

Methods and material for containment and cleaning up

For small amounts: Pick up with suitable absorbent material (e.g. sand, sawdust, etc.). Dispose of absorbed material in accordance with regulations.

For large amounts: Pump off products

Reference to other sections

See Section 7 for information on safe handling

See Section 8 for information on personal protective equipment

See Section 13 for disposal information

Precautions for safe handling

Precautions for safe handling:

Handle in accordance with good industrial hygiene and safety practice. Ensure adequate ventilation.

Hygiene measures:

General occupational hygiene measures are required to ensure safe handling of the product. These measures involve good personal and house-keeping practices. Wash hands after use if contaminated. Avoid wearing contaminated clothing. In dusty environment, wear dust mask, protective goggles and gloves.

Conditions for safe storage, including any incompatibilities

Storage conditions:

Store protected against freezing

Incompatible products:

See section 10

Incompatible materials:

See section 10

Storage area:

The product should be stored in a cool, dry and well-ventilated area, at ambient temperature directly out of the sunlight.



Safety Data Sheet

Section 8: Exposure controls/personal protection

Control parameters

Occupational exposure limits:

No occupational exposure limits known

Exposure controls

Appropriate engineering controls:

Ensure adequate ventilation

Personal protective equipment:

Wear fire-proof clothing, protective goggles and gloves. Wear respiratory protection in a poor ventilated environment.

Hand protection:

Wear chemically resistant protective gloves

Eye protection:

Chemical goggles or safety glasses with side-shields should be worn especially in a splashing environment. Use contact lenses solely is not recommended.

Respiratory protection:

Wear respiratory protection if ventilation is inadequate.

Thermal hazard protection:

Wear suitable protection clothing

Other information:

Hands or face should be washed before breaks and at the end of and shift. Avoid contact with skin and eyes.

Section 9: Physical and chemical properties

Information on basic physical and chemical properties

Physical state:

Liquid

Appearance:

Watery viscosity

Color:

Milky White

Odor:

Sweet

Odor threshold:

Not available

pH:

7.5 – 9.0



Safety Data Sheet

Relative evaporation rate (butyl acetate=1):	<1 Slower
Melting point:	Not available
Boiling point:	>212 ° F
Auto-ignition temperature:	Not available
Decomposition temperature:	Not Determined
Flammability (solid, gas):	Not Applicable
Vapor pressure:	>18.62 mm Hg @ 20 ° C
Flash Point:	Not Applicable
Flash Point Method:	Not Applicable
Relative vapor density @ 20 ° C:	
Relative density:	1.05
Density:	lbs / gal
Solubility:	Completely miscible
Log Pow:	Not available
Log Kow:	Not available
Viscosity, kinematic:	Not available
Viscosity, dynamic:	Not available
Explosive properties:	Non-explosive
Oxidizing properties:	None known
Explosive limits:	Not Applicable

Other information:

No further relevant information available

Section 10: Stability and reactivity

Reactivity

Corrosive effects to metal are not anticipated and not fire propagating

Chemical Stability

Product is stable under normal storage conditions

Conditions to Avoid

Avoid extreme heat and freezing conditions

Incompatible Materials

Oxidizing agents (i.e. perchlorates, nitrates etc.), and reactive metals (i.e. sodium, calcium, zinc etc.). Reaction with peroxides may result in violent decomposition with the possibility of creating an explosion.

Hazardous Decomposition Products

(From burning, heating or reaction with other materials): Carbon Monoxide and Carbon Dioxide in a fire. Irritating and toxic fumes are produced at elevated temperatures. Aldehydes are also produced.



Safety Data Sheet

Section 11: Toxicological information

Information on toxicological effects

TOXICITY MEASURES:

Primary routes of exposure:

Routes of entry are ingestion and inhalation, but may include eye or skin contact.

Acute toxicity:

Assessment of acute toxicity: Virtually non-toxic after a single ingestion. Virtually non-toxic after a single skin contact. Virtually non-toxic after inhalation. Ingestion may cause gastrointestinal disturbances.

Chronic toxicity:

No delayed chronic test data are known

Other information:

The product is considered to be harmless to health if used in the correct manner

Section 12: Ecological information

All work practices must be aimed at eliminating environmental contamination.

Toxicity

As far as present knowledge, the product is non-toxic

Persistence and degradability

The product can be virtually eliminated from water by abiotic processes e.g. adsorption onto activated sludge.

Bioaccumulation:

Accumulation in organisms is not to be expected

Mobility

No data available

Other adverse effects

Not determined for this product

Section 13: Disposal considerations

Waste treatment methods

Regional legislation (waste):

Dispose of waste and unused contents in accordance with national and local regulations.



Safety Data Sheet

Waste disposal recommendations:

Ensure the use of properly authorized waste management companies where appropriate or uncertain.

Section 14: Transport information

The product is not covered by the international regulation on the transport of dangerous goods (IMDG, IATA, ADR/RID) and therefore no classification is required.

Section 15: Regulatory information

U.S. Federal Regulations

U.S. OSHA Regulatory Status:

This material is classified as hazardous under OSHA regulations

U.S SARA Reporting Requirements:

The following components of this product are subject to reporting requirements of sections 302, 304 and 313 of Title III of the Superfund Amendments and Reauthorization Act.

CHEMICAL	SECTION 302 EHS (TPQ) (40 CFR 355, Appendix A)	SECTION 304 RQ (40 CFR Table 302.4)	SECTION 313 TRI (40 CFR 372.65)

Not considered hazardous

A Section 311/312 (40 CFR 370) Hazard Categories:

ACUTE: No; CHRONIC: Yes; FIRE: No; REACTIVE: No; SUDDEN RELEASE: No

Toxic Substances Control Act (TSCA):

All components of this product are included on the TSCA inventory

U.S. CERCLA Reportable Quantity (RQ):

This product is not listed under CERCLA

U.S. Clean Air Act Threshold Quantity (TQ):

This product is not listed.

U.S. Clean Water Act Requirements:

This product is not listed

California Safe Drinking Water and Toxic Enforcement Act (Proposition 65):

This product contains crystalline silica, quartz and may also contain trace amounts of other chemicals known to the State of California to cause cancer, birth defects or other reproductive harm.

Canadian WHMIS Classification:

.

Canadian Environmental Protection Act (CEPA) Priorities Substances Lists:

European Inventory of Existing Chemicals (EINECS):



Safety Data Sheet

All of the components of this product are included on EINECS.

Section 16: Other information

Indication of changes:

Other information:

Full text of H phrases:



NFPA health hazard: 1-May be irritating

NFPA fire hazard: 1-Combustible if heated

NFPA reactivity: 0-Normally stable, even under fire exposure conditions, and not reactive with water

Notice to Reader

The information provided herein is believed to be accurate at the time of preparation or prepared from sources deemed to be reliable, but it is the full responsibility of the user to investigate and comprehend other pertinent sources of information, to comply with all laws and procedures applicable to the safe handling and use of the product and to determine the suitability of the product for its intended use. Enduro Products **makes no warranty, expressed or implied, concerning the product or merchantability or fitness thereof for any purpose or concerning the accuracy of any information provided by Enduro Products**, except that the product shall conform to Enduro Products' specification.

Safety Data Sheet

Section 1: Identification of the Product/Company

Product Identifier:

Product Name: ENDURO-KOTE EKC Cementitious Mix ----- EKC Gray or White
ENDURO-DEK Colored Cementitious Mix ----- Enduro-Dek

Product Code:

Relevant identified uses of the substance or mixture

Recommended use:

For professional use in the construction industry

Uses advised against:

None identified

Details of the supplier of the safety data sheet

Manufacturer:

Enduro Products
1133 N. Pratt Street
Anaheim, CA 92801
United States
www.endurokote.com

Telephone (General)

(714) 526-5898

Emergency telephone number

Manufacturer: (714) 526-5898 USA

Section 2: Hazards Identification

Classification of the substance or mixture

GHS-US classification

Skin Corrosion/Irritation:	Category 2, H315
Eye Damage:	Category 1, H318
Skin Sensitization:	Category 1, H317
Carcinogenicity:	Category 1A, H350
Specific target organ systemic toxicity (single exposure):	Category 3, H335
Specific target organ systemic toxicity (repeated exposure):	Category 1, H372

Label elements

GHS-US labeling

Safety Data Sheet

The substance is classified and labeled according to the Globally Harmonized System (GHS).

Hazard Pictograms (GHS-US)

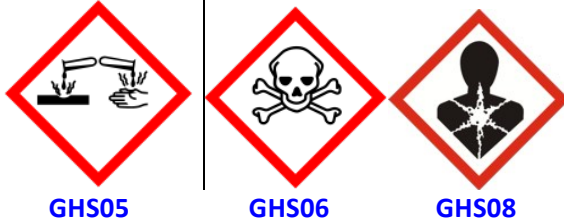

Signal words (GHS-US):

Danger

Hazards statements (GHS-US):

H315 Causes skin irritation
H317 May cause an allergic skin reaction
H318 Causes serious eye damage
H335 May cause respiratory irritation
H350 May cause cancer
H372 Cause damage to organs through prolonged or repeated use

Precautionary statements (GHS-US)

Prevention:

P102 Keep out of reach of children
P280 Wear protective gloves, clothing, and eye/face protection

Response:

P305 + P351 + P338 + P310: If in eyes: Rinse cautiously with water for several minutes. Remove contact lenses if present and easy to do. Continue rinsing. Immediately call a Poison Center or doctor/physician.
P302 + P352 + P333 + P313: Wash with plenty of soap and water. If skin irritation or rash occurs: Get medical advice/attention
P261 + P304 + P340 + P312: Avoid breathing dust/fumes, gas, mist, vapors, spray. IF INHALED: Remove victim to fresh air and keep at rest in a position comfortable for breathing. Call a poison center or doctor/physician

Safety Data Sheet

Storage:

P403+P233 store in a well-ventilated place. Keep container tightly closed
P403 + P235 Store in a well-ventilated place. Keep cool
P405 Store locked up

Disposal:

P501 Dispose of contents and containers in accordance with local, regional and international regulations

Precautionary statements are listed according to the United Nations Globally Harmonized System of Classification and Labeling of Chemicals (GHS)-Annex III

Other hazards

No other information available

Unknown acute toxicity (GHS-US)

No data available

Section 3: Composition/information on ingredients

Substances

Name	Product Identifier	% by weight	GHS-US classification
Ordinary Portland Cement	CAS # 65997-15-1	5-30	Skin irritant 2, H315 STOT SE 3, H335 Eye irritant, H318 Skin sensitization 1, H317
Sand	CAS # 14808-60-7	55-85	STOT SE 3, H335 STOT RE 1, H372 Carc. 1A, H350

Amounts specified are typical and do not represent a specification. Any other ingredients are either proprietary, non-hazardous or present in amounts below the reportable limits.

Section 4: First aid measures

Description of necessary first aid measures

First-aid measures general:

Safety Data Sheet

Symptoms of poisoning may even occur after several hours; therefore medical observation for at least 48 hours after the accident.

First-aid measures after inhalation:

If affected, remove to fresh air. Dust in throat or nasal passage should clear spontaneously. Get medical attention if irritation persists or any discomfort, coughing or other symptoms continue or do not subside.

First-aid measures after skin contact:

Immediately remove contaminated clothing and shoes. Launder clothing before reuse. Seek medical attention if symptoms of irritation or burns occur.

First-aid measures after eye contact:

Do not rub eyes as additional corneal damage will continue to occur. Remove any contact lenses and open eyelids widely to flush immediately by thoroughly rinsing with plenty of clean water for at least 45 minutes to remove all particles. If possible use isotonic water (0.9% Sodium Chloride). Contact an eye specialist immediately.

First-aid measures after ingestion:

Do not induce vomiting. Call a physician or poison control center immediately for further instructions. Never give anything by mouth to an unconscious or convulsing person. If person is conscious, rinse out the mouth with water and give plenty of water to drink. Get medical attention immediately.

Most important and effects, both acute and delayed

Symptoms:

Irritation may occur. Pre-existing skin problems may be aggravated by prolonged or repeated contact.

Indication of any immediate medical attention and special treatment needed

Treat symptomatically

Section 5: Firefighting measures

Extinguishing media

Suitable extinguishing media:

All type of extinguishing media are suitable

Unsuitable extinguishing media:

None known

Special hazards arising from the substance or mixture

Fire hazard:

Poses no fire related hazard. Non-combustible material

Explosion hazard:

Non-explosive

Reactivity:

Safety Data Sheet

Will not facilitate or support combustion of other materials.

Advice for firefighters

Firefighting instructions:

Not required

Protection during firefighting:

No need for specialist fire-fighting equipment.

Additional information

Section 6: Accidental release measures

Personal precautions, protective equipment and emergency procedures

General measures:

Wear protective equipment as described under Section 8 and follow the advice of safe handling and use given under Section 7. Emergency procedures are not required.

For non-emergency personnel

Protective equipment:

Wear chemical resistance (impervious) gloves

Emergency procedures:

None required

For emergency responders

Protective equipment:

Not Applicable

Emergency procedures:

Not Applicable

Environmental precautions

Do not allow to enter drains, sewers or watercourses.

Methods and material for containment and cleaning up

For containment:

Recover spillage in a dry state if possible.

Methods for cleaning up:

Use dry cleanup methods that do not promote airborne dispersions e.g.

Vacuum cleaner (Industrial portable units, equipped with high efficiency particulate filters (HEPA filter) or equivalent technique).

- Wipe up the dust by mopping, wet brushing or water sprays or hoses (fine mist to avoid the dust becoming airborne) and remove slurry. If not possible, remove by slurring with water (see Wet product).

When wet cleaning or vacuum cleaning is not possible and only dry cleaning with brushes can be done, ensure that the workers wear appropriate personal protective equipment and prevent dust from spreading.

Safety Data Sheet

Avoid inhalation of product and contact with skin. Place spilled materials into a container. Solidify before disposal as described under Heading 13.

Wet product: Clean up wet product and place in a container. Allow material to dry and solidify before disposal as described under Heading 13.

Reference to other sections

See Section 7 for information on safe handling

See Section 8 for information on personal protective equipment

See Section 13 for disposal information

Section 7: Handling and storage

Do not handle or store near food and beverages or smoking material

Precautions for safe handling

Precautions for safe handling:

Do not ingest, avoid contact with skin and avoid contact with eyes. Avoid generating dust.

Hygiene measures:

General occupational hygiene measures are required to ensure safe handling of the product. These measures involve good personal and house-keeping practices. Wash hands after use if contaminated. Avoid wearing contaminated clothing. In dusty environment, wear dust mask, protective goggles and gloves.

Conditions for safe storage, including any incompatibilities

Storage conditions:

Bulk material should be stored in silos that are waterproof. Packed products should be stored in unopened bags clear of the ground in cool, dry conditions and protected from excessive draught, humid conditions and excesses of temperatures to avoid degradation of quality.

Incompatible products:

See section 10

Incompatible materials:

See section 10

Storage area:

The product should be stored in a cool, dry and well-ventilated area, at ambient temperature directly out of the sunlight.

Special rules on packaging:

Bags should be stacked in a stable manner. Do not use Aluminum containers due to incompatibility of the materials.

Specific end use(s)

Section 8: Exposure controls/personal protection

Safety Data Sheet

Control parameters

Occupational exposure limits:

Chemical Name	CAS #	EXPOSURE LIMITS
Ordinary Portland Cement	65997-15-1	OSHA PEL 5mg/m ³ ACGIH TLV 1mg/m ³
Sand	14808-60-7	OSHA PEL .05 mg/m ³ ACGIH TLV .025 mg/m ³

Exposure controls

Appropriate engineering controls:

Use only with adequate ventilation. If the operation generates dust, use process enclosures, local exhaust ventilation or other engineering controls to keep worker exposure of airborne particulates below any recommended or statutory limits

Personal protective equipment:

Wear fire-proof clothing, protective goggles and gloves. Wear respiratory protection in a poor ventilated environment.

Hand protection:

Wear impervious, waterproof, abrasion and alkali resistant gloves. Do not rely on barrier cream versus abrasion resistant gloves. Do not allow product inside the gloves.

Eye protection:

Chemical goggles or safety glasses with side-shields should be worn especially in a dust environment. Use contact lenses solely is not recommended.

Skin and body protection:

Wear impervious, waterproof, abrasion and alkali resistant boots and protective long sleeved and long legged clothing to protect the skin from contact with this product. Remove any clothing that becomes saturated with this product and thoroughly wash the exposed areas immediately.

Respiratory protection:

Safety Data Sheet

If a risk assessment indicates the necessity for respiratory protection, use a properly fitted particulate filter respirator. Selection of respirator will be based upon the hazards of the product, the known or anticipated exposure levels and the assigned protection factor of the respirator.

Thermal hazard protection:

Wear suitable protection clothing

Other information:

Clean water should always be available for skin and emergency (eye) washing. Periodically wash any area contacted with the product using a pH neutral soap and uncontaminated water. When using, do not eat, drink or smoke

Section 9: Physical and chemical properties

Information on basic physical and chemical properties

Physical state:	Solid
Appearance:	Powdery material
Color:	Gray, White, Mushroom, Saltillo, Sauterne, Parchment, Cinnamon, Limestone, Sand Beige, Copper Beech and Slate Gray
Odor:	Odorless
Odor threshold:	Not available
pH:	12-13
Relative evaporation rate (butyl acetate=1):	Not Applicable
Melting point:	Not available
Boiling point:	Not determined
Auto-ignition temperature:	Not available
Decomposition temperature:	Not Determined
Flammability (solid, gas):	Not Applicable
Vapor pressure:	Not Determined
Flash Point:	Not Applicable
Flash Point Method:	Not Applicable
Relative vapor density @ 20 ° C:	0.0
Relative density:	2.5
Density:	20.8 lbs / gal
Solubility:	0.1-1%
Log Pow:	Not available
Log Kow:	Not available
Viscosity, kinematic:	Not available
Viscosity, dynamic:	Not available

Safety Data Sheet

Explosive properties:	Non-explosive
Oxidizing properties:	None known
Explosive limits:	Not Applicable

Other information:

No further relevant information available

Section 10: Stability and reactivity

Reactivity

No data available

Chemical Stability

Product is stable under normal storage conditions

Conditions to Avoid

Avoid humid conditions during storage as this might cause lumps and loss of product quality

Incompatible Materials

Avoid strong acids, bases and strong oxidizers and avoid the uncontrolled use of Aluminum powder in the wet product as Hydrogen will be produced.

Hazardous Decomposition Products

Product will not decompose into other hazardous by-products and will not polymerize

Section 11: Toxicological information

Information on toxicological effects

TOXICITY MEASURES:

Acute toxicity:

Based upon available data, the classification criteria are not met

Skin corrosion/irritation: (Category 2)

When in contact with wet skin may cause thickening, cracking or fissuring on the skin. Prolonged contact in addition with abrasion may cause severe burns.

Serious eye damage/irritation: (Category 1)

Direct contact may cause corneal damage by mechanical stress, immediate or delayed irritation or inflammation. Direct contact by large amounts may cause effects ranging from moderate irritation to chemical burns and blindness.

Respiratory or skin sensitization: (Category 1)

Some individuals may develop eczema upon exposure by the high pH which induces irritant contact dermatitis after prolonged contact. The response may appear in a variety of forms ranging from a mild rash to severe dermatitis. There is no indication of sensitization to the respiratory system.

Germ cell mutagenicity:

This product is not classified as a mutagen

Chronic Health Effects:

Safety Data Sheet

Respirable crystalline silica in the form of quartz or cristobalite from occupational sources is listed by the International Agency for Research on Cancer (IARC) and National Toxicology Program (NTP) as a lung carcinogen. Prolonged exposure to respirable crystalline silica has been known to cause silicosis, a lung disease, which may be disabling. While there may be a factor of individual susceptibility to a given exposure to respirable silica dust, the risk of contracting silicosis and the severity of the disease is clearly related to the amount of dust exposure and the length of time (usually years) of exposure.

Carcinogenicity:

The product contains an ingredient that may cause cancer.

Reproductive toxicity:

Developmental: Based on available data, the criteria are not met

Teratogenicity: Not hazardous by WHMIS/OSHA criteria

Embryotoxicity: Not hazardous by WHMIS/OSHA criteria

Fertility: Based on available data, the criteria are not met

Specific target organ toxicity (single exposure):

May cause respiratory irritation

Specific target organ toxicity (repeated exposure):

May cause damage to organs through prolonged or repeated exposure

Aspiration hazard:

Based on available data, the criteria are not met

Other information:

Not available

Section 12: Ecological information

All work practices must be aimed at eliminating environmental contamination.

Toxicity

The product is not expected to be hazardous to the environment, but because of its high alkalinity the product may be toxic to aquatic life under certain conditions.

Persistence and degradability

Not relevant as the components are inorganic and after hardening presents no toxicity risks.

Mobility

Products is not volatile but may become airborne during handling operation.

Other adverse effects

Not determined for this product

Section 13: Disposal considerations

Safety Data Sheet

Waste treatment methods

Regional legislation (waste):

Dispose of waste and unused contents in accordance with national and local regulations.

Waste disposal recommendations:

Ensure the use of properly authorized waste management companies where appropriate or uncertain.

Section 14: Transport information

The product is not covered by the international regulation on the transport of dangerous goods (IMDG, IATA, ADR/RID) and therefore no classification is required.

Section 15: Regulatory information

U.S. Federal Regulations

U.S. OSHA Regulatory Status:

This material is classified as hazardous under OSHA regulations

U.S SARA Reporting Requirements:

The following components of this product are subject to reporting requirements of sections 302, 304 and 313 of Title III of the Superfund Amendments and Reauthorization Act.

CHEMICAL	SECTION 302 EHS (TPQ) (40 CFR 355, Appendix A)	SECTION 304 RQ (40 CFR Table 302.4)	SECTION 313 TRI (40 CFR 372.65)
Ordinary Portland Cement	No	No	No
Sand	No	No	No

A Section 311/312 (40 CFR 370) Hazard Categories:

ACUTE: Yes; CHRONIC: Yes; FIRE: No; REACTIVE: No; SUDDEN RELEASE: No

Toxic Substances Control Act (TSCA):

All components of this product are included on the TSCA inventory

U.S. CERCLA Reportable Quantity (RQ):

This product is not listed under CERCLA

U.S. Clean Air Act Threshold Quantity (TQ):

This product is not listed.

U.S. Clean Water Act Requirements:

This product is not listed

California Safe Drinking Water and Toxic Enforcement Act (Proposition 65):

This product contains crystalline silica, quartz and may also contain trace amounts of other chemicals known to the State of California to cause cancer, birth defects or other reproductive harm.

Canadian WHMIS Classification:

Safety Data Sheet

Canadian Environmental Protection Act (CEPA) Priorities Substances Lists:

European Inventory of Existing Chemicals (EINECS):

All of the components of this product are included on EINECS.

Section 16: Other information

Indication of changes:

Other information:

Full text of H phrases:

STOT SE 3	Specific Target Organ Toxicity-Single Exposure, Category 3, Narcosis
STOT RE 1	Specific Target Organ Toxicity-Repeated Exposure, Category 1



NFPA health hazard: 2-Moderately toxic or hazardous material which require additional PPE or equipment other than safety goggles and gloves.

NFPA fire hazard: 0-Material is not combustible

NFPA reactivity: 0-Normally stable, even under fire exposure conditions, and not reactive with water

Notice to Reader

The information provided herein is believed to be accurate at the time of preparation or prepared from sources deemed to be reliable, but it is the full responsibility of the user to investigate and comprehend other pertinent sources of information, to comply with all laws and procedures applicable to the safe handling and use of the product and to determine the suitability of the product for its intended use. Enduro Products **makes no warranty, expressed or implied, concerning the product or merchantability or fitness thereof for any purpose or concerning the accuracy of any information provided by Enduro Products**, except that the product shall conform to Enduro Products' specification.



Safety Data Sheet

Section 1: Identification of the Product/Company

Product Identifier:

Product Name: Enduro-Lastic ELA Binder

Product Code:

Relevant identified uses of the substance or mixture

Recommended use:

For professional use in the construction industry

Uses advised against:

None identified

Details of the supplier of the safety data sheet

Manufacturer:

Enduro Products
1133 N. Pratt Street
Anaheim, CA 92801
United States
www.endurokote.com
(714) 526-5898

Telephone (General)

Emergency telephone number

Manufacturer: (714) 526-5898 USA

Section 2: Hazards Identification

Classification of the substance or mixture

GHS-US classification

No need for classification according to GHS criteria for this product

Label elements

GHS-US labeling

The product does not require a hazard warning label in accordance with GHS criteria.

Other hazards

No other information available

Unknown acute toxicity (GHS-US)



Safety Data Sheet

No data available

Section 3: Composition/information on ingredients

Substances

Name	Product Identifier	% by weight	GHS-US classification
Acrylic copolymer dispersion Non hazardous components VOC= 0 grams/ltr	Trade secret	20-60	NA

Amounts specified are typical and do not represent a specification. Any other ingredients are either proprietary, non-hazardous or present in amounts below the reportable limits.

Section 4: First aid measures

Description of necessary first aid measures

First-aid measures general:

Remove contaminated clothing

First-aid measures after inhalation:

If affected, remove to fresh air. Assist in breathing if necessary

First-aid measures after skin contact:

Immediately remove contaminated clothing and shoes. Launder clothing before reuse. Seek medical attention if symptoms of irritation or burns occur.

First-aid measures after eye contact:

Flush with copious amount of water for at least 15 minutes. If irritation develops, seek medical attention.

First-aid measures after ingestion:

Do not induce vomiting. Call a physician or poison control center immediately for further instructions. Never give anything by mouth to an unconscious or convulsing person. If person is conscious, rinse out the mouth with water and give plenty of water to drink. Get medical attention immediately.

Most important and effects, both acute and delayed

Symptoms:



Safety Data Sheet

None expected due to the non-classification of the product.

Indication of any immediate medical attention and special treatment needed

Treat symptomatically

Section 5: Firefighting measures

Extinguishing media

Suitable extinguishing media:

Water spray, foam, dry powder

Unsuitable extinguishing media:

None known

Special hazards arising from the substance or mixture

Fire hazard:

Poses no fire related hazard. No particular hazards known

Explosion hazard:

Non-explosive

Reactivity:

Will not facilitate or support combustion of other materials.

Advice for firefighters

Firefighting instructions:

Not required

Protection during firefighting:

Firefighters should be equipped with self-contained breathing apparatus and turn out gear.

Additional information

Section 6: Accidental release measures

Personal precautions, protective equipment and emergency procedures

General measures:

Wear protective equipment as described under Section 8 and follow the advice of safe handling and use given under Section 7. Emergency procedures are not required.

For non-emergency personnel

Protective equipment:

Wear chemical resistance (impervious) gloves

Emergency procedures:

High risk of slipping due to spillage/leakage of product



Safety Data Sheet

For emergency responders

Protective equipment:

Not Applicable

Emergency procedures:

Not Applicable

Environmental precautions

Do not allow to enter drains, sewers or watercourses.

Methods and material for containment and cleaning up

For small amounts: Pick up with suitable absorbent material (e.g. sand, sawdust, etc.). Dispose of absorbed material in accordance with regulations.

For large amounts: Pump off products

Reference to other sections

See Section 7 for information on safe handling

See Section 8 for information on personal protective equipment

See Section 13 for disposal information

Precautions for safe handling

Precautions for safe handling:

Handle in accordance with good industrial hygiene and safety practice. Ensure adequate ventilation.

Hygiene measures:

General occupational hygiene measures are required to ensure safe handling of the product. These measures involve good personal and house-keeping practices. Wash hands after use if contaminated. Avoid wearing contaminated clothing. In dusty environment, wear dust mask, protective goggles and gloves.

Conditions for safe storage, including any incompatibilities**Storage conditions:**

Store protected against freezing

Incompatible products:

See section 10

Incompatible materials:

See section 10

Storage area:

The product should be stored in a cool, dry and well-ventilated area, at ambient temperature directly out of the sunlight.



Safety Data Sheet

Section 8: Exposure controls/personal protection

Control parameters

Occupational exposure limits:

No occupational exposure limits known

Exposure controls

Appropriate engineering controls:

Ensure adequate ventilation

Personal protective equipment:

Wear protective goggles and gloves. Wear respiratory protection in a poor ventilated environment.

Hand protection:

Wear chemically resistant protective gloves

Eye protection:

Chemical goggles or safety glasses with side-shields should be worn especially in a splashing environment. Use contact lenses solely is not recommended.

Respiratory protection:

Wear respiratory protection if ventilation is inadequate.

Thermal hazard protection:

Wear suitable protection clothing

Other information:

Hands or face should be washed before breaks and at the end of and shift. Avoid contact with skin and eyes.

Section 9: Physical and chemical properties

Information on basic physical and chemical properties

Physical state:

Liquid

Appearance:

Watery viscosity

Color:

Milky White



Safety Data Sheet

Odor:	Sweet
Odor threshold:	Not available
pH:	7.5 – 9.0
Relative evaporation rate (butyl acetate=1):	<1 Slower
Melting point:	Not available
Boiling point:	>212 ° F
Auto-ignition temperature:	Not available
Decomposition temperature:	Not Determined
Flammability (solid, gas):	Not Applicable
Vapor pressure:	>18.62 mm Hg @ 20 ° C
Flash Point:	Not Applicable
Flash Point Method:	Not Applicable
Relative vapor density @ 20 ° C:	
Relative density:	1.05
Density:	lbs / gal
Solubility:	Completely miscible
Log Pow:	Not available
Log Kow:	Not available
Viscosity, kinematic:	Not available
Viscosity, dynamic:	Not available
Explosive properties:	Non-explosive
Oxidizing properties:	None known
Explosive limits:	Not Applicable

Other information:

No further relevant information available

Section 10: Stability and reactivity

Reactivity

Corrosive effects to metal are not anticipated and not fire propagating

Chemical Stability

Product is stable under normal storage conditions

Conditions to Avoid

Avoid extreme heat and freezing conditions

Incompatible Materials

Oxidizing agents (i.e. perchlorates, nitrates etc.), and reactive metals (i.e. sodium, calcium, zinc etc.). Reaction with peroxides may result in violent decomposition with the possibility of creating an explosion.

Hazardous Decomposition Products



Safety Data Sheet

(From burning, heating or reaction with other materials): Carbon Monoxide and Carbon Dioxide in a fire. Irritating and toxic fumes are produced at elevated temperatures. Aldehydes are also produced.

Section 11: Toxicological information

Information on toxicological effects

TOXICITY MEASURES:

Primary routes of exposure:

Routes of entry are ingestion and inhalation, but may include eye or skin contact.

Acute toxicity:

Assessment of acute toxicity: Virtually non-toxic after a single ingestion. Virtually non-toxic after a single skin contact. Virtually non-toxic after inhalation. Ingestion may cause gastrointestinal disturbances.

Chronic toxicity:

No delayed chronic test data are known

Other information:

The product is considered to be harmless to health if used in the correct manner

Section 12: Ecological information

All work practices must be aimed at eliminating environmental contamination.

Toxicity

As far as present knowledge, the product is non-toxic

Persistence and degradability

The product can be virtually eliminated from water by abiotic processes e.g. adsorption onto activated sludge.

Bioaccumulation:

Accumulation in organisms is not to be expected

Mobility

No data available

Other adverse effects

Not determined for this product

Section 13: Disposal considerations



Safety Data Sheet

Waste treatment methods

Regional legislation (waste):

Dispose of waste and unused contents in accordance with national and local regulations.

Waste disposal recommendations:

Ensure the use of properly authorized waste management companies where appropriate or uncertain.

Section 14: Transport information

The product is not covered by the international regulation on the transport of dangerous goods (IMDG, IATA, ADR/RID) and therefore no classification is required.

Section 15: Regulatory information

U.S. Federal Regulations

U.S. OSHA Regulatory Status:

This material is classified as hazardous under OSHA regulations

U.S SARA Reporting Requirements:

The following components of this product are subject to reporting requirements of sections 302, 304 and 313 of Title III of the Superfund Amendments and Reauthorization Act.

CHEMICAL	SECTION 302 EHS (TPQ) (40 CFR 355, Appendix A)	SECTION 304 RQ (40 CFR Table 302.4)	SECTION 313 TRI (40 CFR 372.65)

Not considered hazardous

A Section 311/312 (40 CFR 370) Hazard Categories:

ACUTE: No; CHRONIC: Yes; FIRE: No; REACTIVE: No; SUDDEN RELEASE: No

Toxic Substances Control Act (TSCA):

All components of this product are included on the TSCA inventory

U.S. CERCLA Reportable Quantity (RQ):

This product is not listed under CERCLA

U.S. Clean Air Act Threshold Quantity (TQ):

This product is not listed.

U.S. Clean Water Act Requirements:

This product is not listed

California Safe Drinking Water and Toxic Enforcement Act (Proposition 65):

This product contains crystalline silica, quartz and may also contain trace amounts of other chemicals known to the State of California to cause cancer, birth defects or other reproductive harm.

Canadian WHMIS Classification:

.



Safety Data Sheet

Canadian Environmental Protection Act (CEPA) Priorities Substances Lists:

European Inventory of Existing Chemicals (EINECS):

All of the components of this product are included on EINECS.

Section 16: Other information

Indication of changes:

Other information:

Full text of H phrases:



NFPA health hazard: 1-May be irritating

NFPA fire hazard: 1-Combustible if heated

NFPA reactivity: 0-Normally stable, even under fire exposure conditions, and not reactive with water

Notice to Reader

The information provided herein is believed to be accurate at the time of preparation or prepared from sources deemed to be reliable, but it is the full responsibility of the user to investigate and comprehend other pertinent sources of information, to comply with all laws and procedures applicable to the safe handling and use of the product and to determine the suitability of the product for its intended use. Enduro Products **makes no warranty, expressed or implied, concerning the product or merchantability or fitness thereof for any purpose or concerning the accuracy of any information provided by Enduro Products**, except that the product shall conform to Enduro Products' specification.

Safety Data Sheet

Section 1: Identification of the Product/Company

Product Identifier:

Product Name: ENDURO-KOTE EKC Cementitious Mix ----- EKC Gray or White
ENDURO-DEK Colored Cementitious Mix ----- Enduro-Dek

Product Code:

Relevant identified uses of the substance or mixture

Recommended use:

For professional use in the construction industry

Uses advised against:

None identified

Details of the supplier of the safety data sheet

Manufacturer:

Enduro Products
1133 N. Pratt Street
Anaheim, CA 92801
United States
www.endurokote.com

Telephone (General)

(714) 526-5898

Emergency telephone number

Manufacturer: (714) 526-5898 USA

Section 2: Hazards Identification

Classification of the substance or mixture

GHS-US classification

Skin Corrosion/Irritation:	Category 2, H315
Eye Damage:	Category 1, H318
Skin Sensitization:	Category 1, H317
Carcinogenicity:	Category 1A, H350
Specific target organ systemic toxicity (single exposure):	Category 3, H335
Specific target organ systemic toxicity (repeated exposure):	Category 1, H372

Label elements

GHS-US labeling

Safety Data Sheet

The substance is classified and labeled according to the Globally Harmonized System (GHS).

Hazard Pictograms (GHS-US)

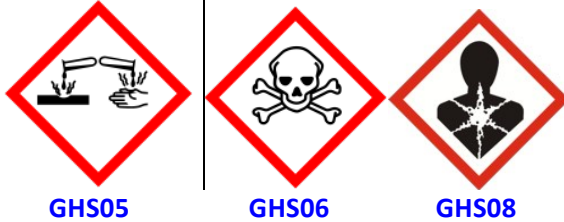

Signal words (GHS-US):

Danger

Hazards statements (GHS-US):

H315 Causes skin irritation
H317 May cause an allergic skin reaction
H318 Causes serious eye damage
H335 May cause respiratory irritation
H350 May cause cancer
H372 Cause damage to organs through prolonged or repeated use

Precautionary statements (GHS-US)

Prevention:

P102 Keep out of reach of children
P280 Wear protective gloves, clothing, and eye/face protection

Response:

P305 + P351 + P338 + P310: If in eyes: Rinse cautiously with water for several minutes. Remove contact lenses if present and easy to do. Continue rinsing. Immediately call a Poison Center or doctor/physician.
P302 + P352 + P333 + P313: Wash with plenty of soap and water. If skin irritation or rash occurs: Get medical advice/attention
P261 + P304 + P340 + P312: Avoid breathing dust/fumes, gas, mist, vapors, spray. IF INHALED: Remove victim to fresh air and keep at rest in a position comfortable for breathing. Call a poison center or doctor/physician

Safety Data Sheet

Storage:

P403+P233 store in a well-ventilated place. Keep container tightly closed
P403 + P235 Store in a well-ventilated place. Keep cool
P405 Store locked up

Disposal:

P501 Dispose of contents and containers in accordance with local, regional and international regulations

Precautionary statements are listed according to the United Nations Globally Harmonized System of Classification and Labeling of Chemicals (GHS)-Annex III

Other hazards

No other information available

Unknown acute toxicity (GHS-US)

No data available

Section 3: Composition/information on ingredients

Substances

Name	Product Identifier	% by weight	GHS-US classification
Ordinary Portland Cement	CAS # 65997-15-1	5-30	Skin irritant 2, H315 STOT SE 3, H335 Eye irritant, H318 Skin sensitization 1, H317
Sand	CAS # 14808-60-7	55-85	STOT SE 3, H335 STOT RE 1, H372 Carc. 1A, H350

Amounts specified are typical and do not represent a specification. Any other ingredients are either proprietary, non-hazardous or present in amounts below the reportable limits.

Section 4: First aid measures

Description of necessary first aid measures

First-aid measures general:

Safety Data Sheet

Symptoms of poisoning may even occur after several hours; therefore medical observation for at least 48 hours after the accident.

First-aid measures after inhalation:

If affected, remove to fresh air. Dust in throat or nasal passage should clear spontaneously. Get medical attention if irritation persists or any discomfort, coughing or other symptoms continue or do not subside.

First-aid measures after skin contact:

Immediately remove contaminated clothing and shoes. Launder clothing before reuse. Seek medical attention if symptoms of irritation or burns occur.

First-aid measures after eye contact:

Do not rub eyes as additional corneal damage will continue to occur. Remove any contact lenses and open eyelids widely to flush immediately by thoroughly rinsing with plenty of clean water for at least 45 minutes to remove all particles. If possible use isotonic water (0.9% Sodium Chloride). Contact an eye specialist immediately.

First-aid measures after ingestion:

Do not induce vomiting. Call a physician or poison control center immediately for further instructions. Never give anything by mouth to an unconscious or convulsing person. If person is conscious, rinse out the mouth with water and give plenty of water to drink. Get medical attention immediately.

Most important and effects, both acute and delayed

Symptoms:

Irritation may occur. Pre-existing skin problems may be aggravated by prolonged or repeated contact.

Indication of any immediate medical attention and special treatment needed

Treat symptomatically

Section 5: Firefighting measures

Extinguishing media

Suitable extinguishing media:

All type of extinguishing media are suitable

Unsuitable extinguishing media:

None known

Special hazards arising from the substance or mixture

Fire hazard:

Poses no fire related hazard. Non-combustible material

Explosion hazard:

Non-explosive

Reactivity:

Safety Data Sheet

Will not facilitate or support combustion of other materials.

Advice for firefighters

Firefighting instructions:

Not required

Protection during firefighting:

No need for specialist fire-fighting equipment.

Additional information

Section 6: Accidental release measures

Personal precautions, protective equipment and emergency procedures

General measures:

Wear protective equipment as described under Section 8 and follow the advice of safe handling and use given under Section 7. Emergency procedures are not required.

For non-emergency personnel

Protective equipment:

Wear chemical resistance (impervious) gloves

Emergency procedures:

None required

For emergency responders

Protective equipment:

Not Applicable

Emergency procedures:

Not Applicable

Environmental precautions

Do not allow to enter drains, sewers or watercourses.

Methods and material for containment and cleaning up

For containment:

Recover spillage in a dry state if possible.

Methods for cleaning up:

Use dry cleanup methods that do not promote airborne dispersions e.g.

Vacuum cleaner (Industrial portable units, equipped with high efficiency particulate filters (HEPA filter) or equivalent technique).

- Wipe up the dust by mopping, wet brushing or water sprays or hoses (fine mist to avoid the dust becoming airborne) and remove slurry. If not possible, remove by slurring with water (see Wet product).

When wet cleaning or vacuum cleaning is not possible and only dry cleaning with brushes can be done, ensure that the workers wear appropriate personal protective equipment and prevent dust from spreading.

Safety Data Sheet

Avoid inhalation of product and contact with skin. Place spilled materials into a container. Solidify before disposal as described under Heading 13.

Wet product: Clean up wet product and place in a container. Allow material to dry and solidify before disposal as described under Heading 13.

Reference to other sections

See Section 7 for information on safe handling

See Section 8 for information on personal protective equipment

See Section 13 for disposal information

Section 7: Handling and storage

Do not handle or store near food and beverages or smoking material

Precautions for safe handling

Precautions for safe handling:

Do not ingest, avoid contact with skin and avoid contact with eyes. Avoid generating dust.

Hygiene measures:

General occupational hygiene measures are required to ensure safe handling of the product. These measures involve good personal and house-keeping practices. Wash hands after use if contaminated. Avoid wearing contaminated clothing. In dusty environment, wear dust mask, protective goggles and gloves.

Conditions for safe storage, including any incompatibilities

Storage conditions:

Bulk material should be stored in silos that are waterproof. Packed products should be stored in unopened bags clear of the ground in cool, dry conditions and protected from excessive draught, humid conditions and excesses of temperatures to avoid degradation of quality.

Incompatible products:

See section 10

Incompatible materials:

See section 10

Storage area:

The product should be stored in a cool, dry and well-ventilated area, at ambient temperature directly out of the sunlight.

Special rules on packaging:

Bags should be stacked in a stable manner. Do not use Aluminum containers due to incompatibility of the materials.

Specific end use(s)

Section 8: Exposure controls/personal protection

Safety Data Sheet

Control parameters

Occupational exposure limits:

Chemical Name	CAS #	EXPOSURE LIMITS
Ordinary Portland Cement	65997-15-1	OSHA PEL 5mg/m ³ ACGIH TLV 1mg/m ³
Sand	14808-60-7	OSHA PEL .05 mg/m ³ ACGIH TLV .025 mg/m ³

Exposure controls

Appropriate engineering controls:

Use only with adequate ventilation. If the operation generates dust, use process enclosures, local exhaust ventilation or other engineering controls to keep worker exposure of airborne particulates below any recommended or statutory limits

Personal protective equipment:

Wear fire-proof clothing, protective goggles and gloves. Wear respiratory protection in a poor ventilated environment.

Hand protection:

Wear impervious, waterproof, abrasion and alkali resistant gloves. Do not rely on barrier cream versus abrasion resistant gloves. Do not allow product inside the gloves.

Eye protection:

Chemical goggles or safety glasses with side-shields should be worn especially in a dust environment. Use contact lenses solely is not recommended.

Skin and body protection:

Wear impervious, waterproof, abrasion and alkali resistant boots and protective long sleeved and long legged clothing to protect the skin from contact with this product. Remove any clothing that becomes saturated with this product and thoroughly wash the exposed areas immediately.

Respiratory protection:

Safety Data Sheet

If a risk assessment indicates the necessity for respiratory protection, use a properly fitted particulate filter respirator. Selection of respirator will be based upon the hazards of the product, the known or anticipated exposure levels and the assigned protection factor of the respirator.

Thermal hazard protection:

Wear suitable protection clothing

Other information:

Clean water should always be available for skin and emergency (eye) washing. Periodically wash any area contacted with the product using a pH neutral soap and uncontaminated water. When using, do not eat, drink or smoke

Section 9: Physical and chemical properties

Information on basic physical and chemical properties

Physical state:	Solid
Appearance:	Powdery material
Color:	Gray, White, Mushroom, Saltillo, Sauterne, Parchment, Cinnamon, Limestone, Sand Beige, Copper Beech and Slate Gray
Odor:	Odorless
Odor threshold:	Not available
pH:	12-13
Relative evaporation rate (butyl acetate=1):	Not Applicable
Melting point:	Not available
Boiling point:	Not determined
Auto-ignition temperature:	Not available
Decomposition temperature:	Not Determined
Flammability (solid, gas):	Not Applicable
Vapor pressure:	Not Determined
Flash Point:	Not Applicable
Flash Point Method:	Not Applicable
Relative vapor density @ 20 ° C:	0.0
Relative density:	2.5
Density:	20.8 lbs / gal
Solubility:	0.1-1%
Log Pow:	Not available
Log Kow:	Not available
Viscosity, kinematic:	Not available
Viscosity, dynamic:	Not available

Safety Data Sheet

Explosive properties:	Non-explosive
Oxidizing properties:	None known
Explosive limits:	Not Applicable

Other information:

No further relevant information available

Section 10: Stability and reactivity

Reactivity

No data available

Chemical Stability

Product is stable under normal storage conditions

Conditions to Avoid

Avoid humid conditions during storage as this might cause lumps and loss of product quality

Incompatible Materials

Avoid strong acids, bases and strong oxidizers and avoid the uncontrolled use of Aluminum powder in the wet product as Hydrogen will be produced.

Hazardous Decomposition Products

Product will not decompose into other hazardous by-products and will not polymerize

Section 11: Toxicological information

Information on toxicological effects

TOXICITY MEASURES:

Acute toxicity:

Based upon available data, the classification criteria are not met

Skin corrosion/irritation: (Category 2)

When in contact with wet skin may cause thickening, cracking or fissuring on the skin. Prolonged contact in addition with abrasion may cause severe burns.

Serious eye damage/irritation: (Category 1)

Direct contact may cause corneal damage by mechanical stress, immediate or delayed irritation or inflammation. Direct contact by large amounts may cause effects ranging from moderate irritation to chemical burns and blindness.

Respiratory or skin sensitization: (Category 1)

Some individuals may develop eczema upon exposure by the high pH which induces irritant contact dermatitis after prolonged contact. The response may appear in a variety of forms ranging from a mild rash to severe dermatitis. There is no indication of sensitization to the respiratory system.

Germ cell mutagenicity:

This product is not classified as a mutagen

Chronic Health Effects:

Safety Data Sheet

Respirable crystalline silica in the form of quartz or cristobalite from occupational sources is listed by the International Agency for Research on Cancer (IARC) and National Toxicology Program (NTP) as a lung carcinogen. Prolonged exposure to respirable crystalline silica has been known to cause silicosis, a lung disease, which may be disabling. While there may be a factor of individual susceptibility to a given exposure to respirable silica dust, the risk of contracting silicosis and the severity of the disease is clearly related to the amount of dust exposure and the length of time (usually years) of exposure.

Carcinogenicity:

The product contains an ingredient that may cause cancer.

Reproductive toxicity:

Developmental: Based on available data, the criteria are not met

Teratogenicity: Not hazardous by WHMIS/OSHA criteria

Embryotoxicity: Not hazardous by WHMIS/OSHA criteria

Fertility: Based on available data, the criteria are not met

Specific target organ toxicity (single exposure):

May cause respiratory irritation

Specific target organ toxicity (repeated exposure):

May cause damage to organs through prolonged or repeated exposure

Aspiration hazard:

Based on available data, the criteria are not met

Other information:

Not available

Section 12: Ecological information

All work practices must be aimed at eliminating environmental contamination.

Toxicity

The product is not expected to be hazardous to the environment, but because of its high alkalinity the product may be toxic to aquatic life under certain conditions.

Persistence and degradability

Not relevant as the components are inorganic and after hardening presents no toxicity risks.

Mobility

Products is not volatile but may become airborne during handling operation.

Other adverse effects

Not determined for this product

Section 13: Disposal considerations

Safety Data Sheet

Waste treatment methods

Regional legislation (waste):

Dispose of waste and unused contents in accordance with national and local regulations.

Waste disposal recommendations:

Ensure the use of properly authorized waste management companies where appropriate or uncertain.

Section 14: Transport information

The product is not covered by the international regulation on the transport of dangerous goods (IMDG, IATA, ADR/RID) and therefore no classification is required.

Section 15: Regulatory information

U.S. Federal Regulations

U.S. OSHA Regulatory Status:

This material is classified as hazardous under OSHA regulations

U.S SARA Reporting Requirements:

The following components of this product are subject to reporting requirements of sections 302, 304 and 313 of Title III of the Superfund Amendments and Reauthorization Act.

CHEMICAL	SECTION 302 EHS (TPQ) (40 CFR 355, Appendix A)	SECTION 304 RQ (40 CFR Table 302.4)	SECTION 313 TRI (40 CFR 372.65)
Ordinary Portland Cement	No	No	No
Sand	No	No	No

A Section 311/312 (40 CFR 370) Hazard Categories:

ACUTE: Yes; CHRONIC: Yes; FIRE: No; REACTIVE: No; SUDDEN RELEASE: No

Toxic Substances Control Act (TSCA):

All components of this product are included on the TSCA inventory

U.S. CERCLA Reportable Quantity (RQ):

This product is not listed under CERCLA

U.S. Clean Air Act Threshold Quantity (TQ):

This product is not listed.

U.S. Clean Water Act Requirements:

This product is not listed

California Safe Drinking Water and Toxic Enforcement Act (Proposition 65):

This product contains crystalline silica, quartz and may also contain trace amounts of other chemicals known to the State of California to cause cancer, birth defects or other reproductive harm.

Canadian WHMIS Classification:

Safety Data Sheet

Canadian Environmental Protection Act (CEPA) Priorities Substances Lists:

European Inventory of Existing Chemicals (EINECS):

All of the components of this product are included on EINECS.

Section 16: Other information

Indication of changes:

Other information:

Full text of H phrases:

STOT SE 3	Specific Target Organ Toxicity-Single Exposure, Category 3, Narcosis
STOT RE 1	Specific Target Organ Toxicity-Repeated Exposure, Category 1



NFPA health hazard: 2-Moderately toxic or hazardous material which require additional PPE or equipment other than safety goggles and gloves.

NFPA fire hazard: 0-Material is not combustible

NFPA reactivity: 0-Normally stable, even under fire exposure conditions, and not reactive with water

Notice to Reader

The information provided herein is believed to be accurate at the time of preparation or prepared from sources deemed to be reliable, but it is the full responsibility of the user to investigate and comprehend other pertinent sources of information, to comply with all laws and procedures applicable to the safe handling and use of the product and to determine the suitability of the product for its intended use. Enduro Products **makes no warranty, expressed or implied, concerning the product or merchantability or fitness thereof for any purpose or concerning the accuracy of any information provided by Enduro Products**, except that the product shall conform to Enduro Products' specification.



ENDURO PRODUCTS

ACRYLIC COLOR SELECTOR

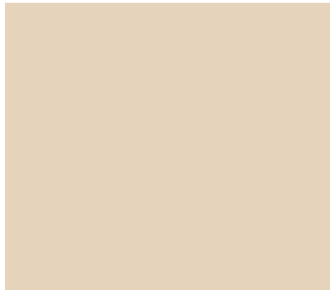

LIGHT BEIGE

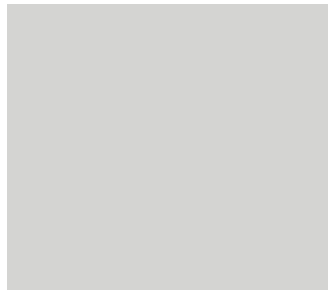

CONCRETE GREY

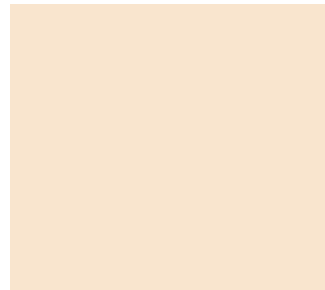

ARIZONA TAN

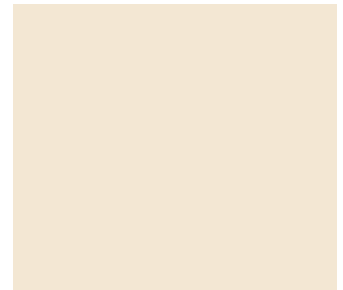

ANTIQUÉ WHITE

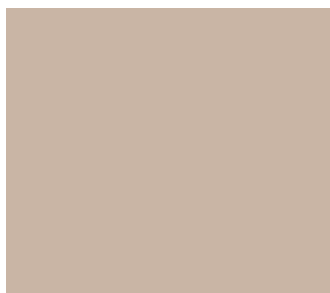

BEIGE



LIGHT GREY

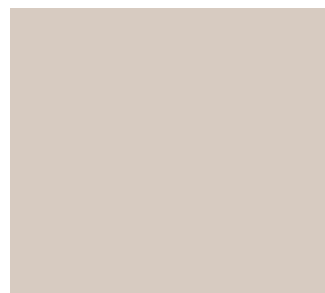

SILTSTONE



LIMESTONE



SANDY TAN



DARK GREY



SANDSTONE



EUCALYPTUS



ADOBE

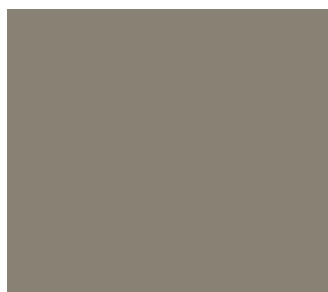

PUTTY

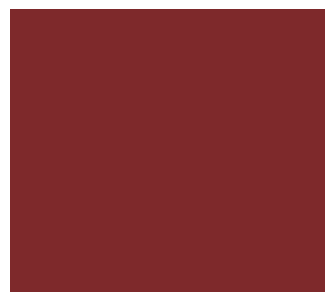

BRICK RED

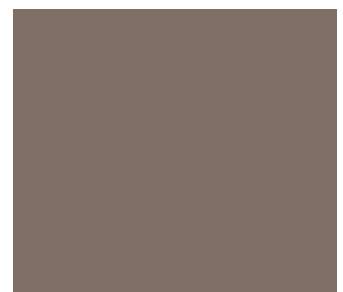

GRANITE

Colors shown may vary. They approximate actual colors as accurately as possible. Custom colors available.

ENDURO PRODUCTS



Corporate Office: 1133 N. Patt Street, Anaheim, California 92801 • Phone: (714) 526-5898 • Fax: (714) 526-6511
Florida Office: 8050 N.W. 66th Street, Miami, Florida 33166 • (941) 378-9794 • Fax: (941) 378-9438
Toll Free: (877) 809-0781 • Email: info@endurokote.com • Website: www.endurokote.com



ENDURO-KOTE XL

APPLICATION DETAIL

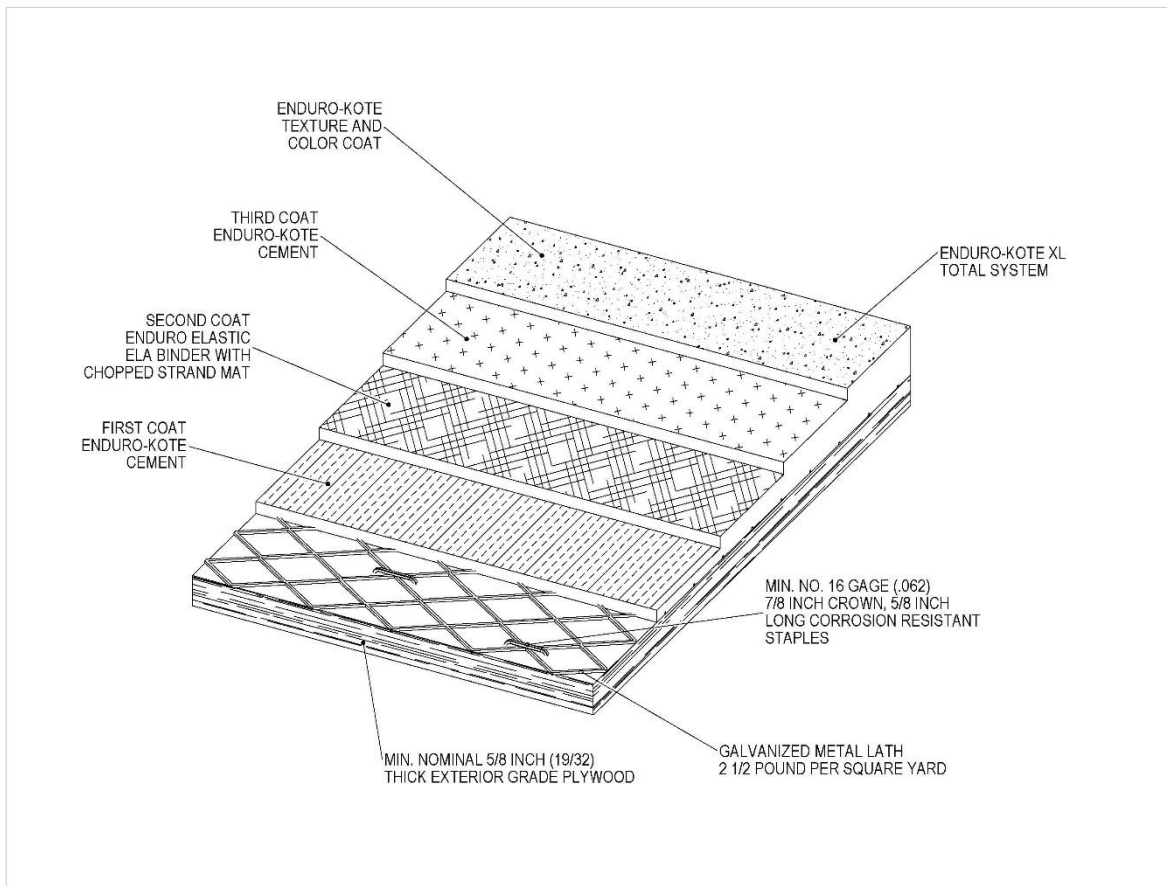

Corporate Office: 1133 N Patt Street, Anaheim, California 92801 - Phone: (714) 526-5898 - Fax (714) 526-6511

Florida Office: 8050 NW 66th Street, Miami, Florida 33166 - Phone: (305) 591-8303 - Fax (941) 378-9438

Toll Free: (877) 809-0781 - Email: info@endurokote.com - Website: www.endurokote.com

Enduro-Kote

REVISED NOVEMBER 2007



ENDURO-KOTE XL

DECK TO WALL DETAIL

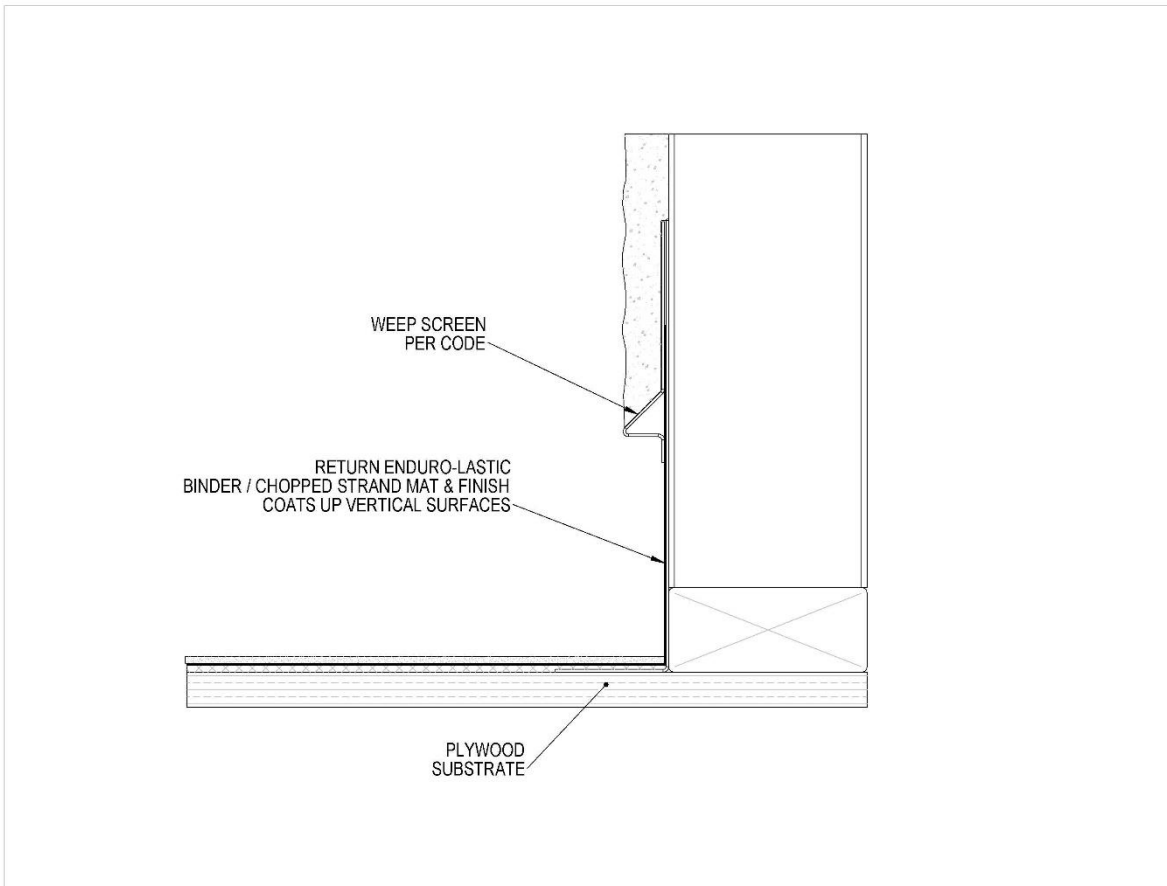

Corporate Office: 1133 N Patt Street, Anaheim, California 92801 - Phone: (714) 526-5898 – Fax (714) 526-6511

Florida Office: 8050 NW 66th Street, Miami, Florida 33166 - Phone: (305) 591-8303 – Fax (941) 378-9438

Toll Free: (877) 809-0781 - Email: info@endurokote.com - Website: www.endurokote.com

Enduro-Kote

REVISED NOVEMBER 2007



ENDURO-KOTE XL

EDGE DETAIL

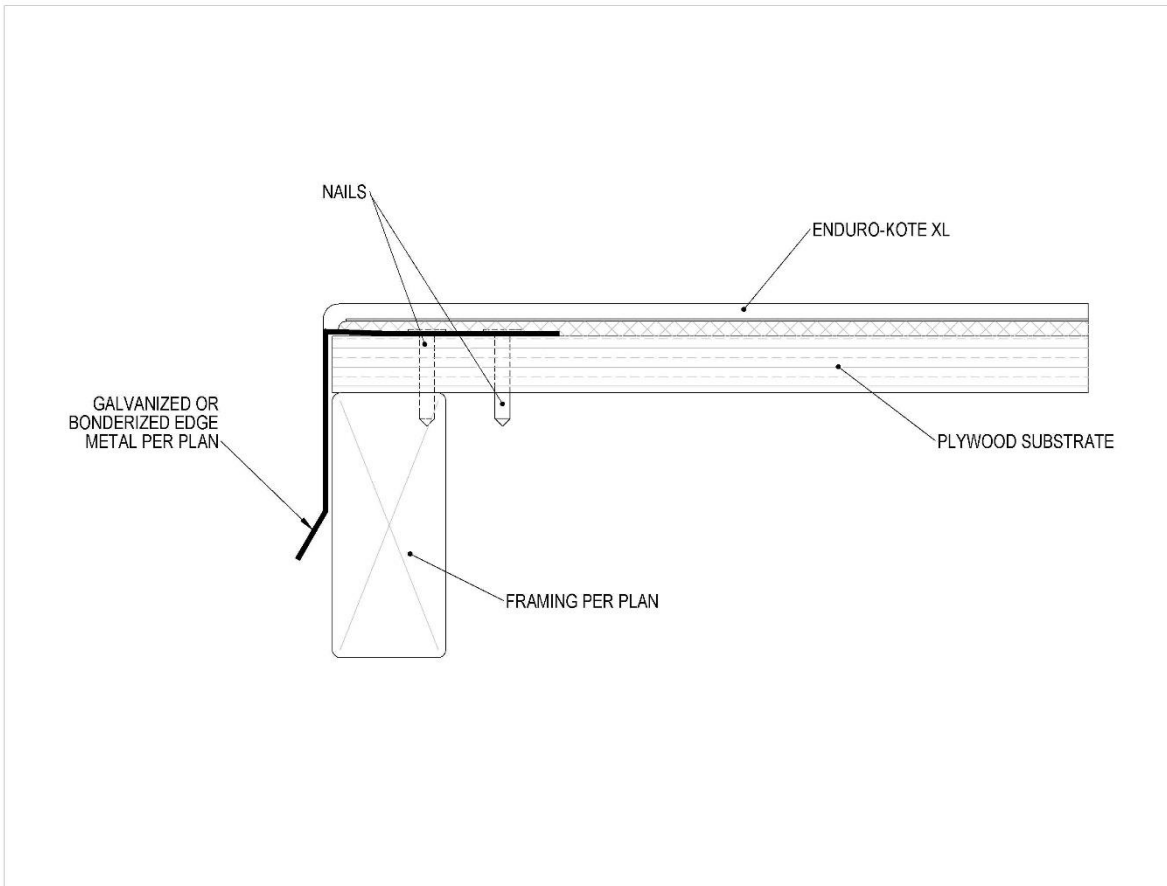

Corporate Office: 1133 N Patt Street, Anaheim, California 92801 - Phone: (714) 526-5898 – Fax (714) 526-6511

Florida Office: 8050 NW 66th Street, Miami, Florida 33166 - Phone: (305) 591-8303 – Fax (941) 378-9438

Toll Free: (877) 809-0781 - Email: info@endurokote.com - Website: www.endurokote.com

Enduro-Kote

REVISED NOVEMBER 2007



ENDURO-KOTE XL

RAILPOST MOUNTING DETAIL

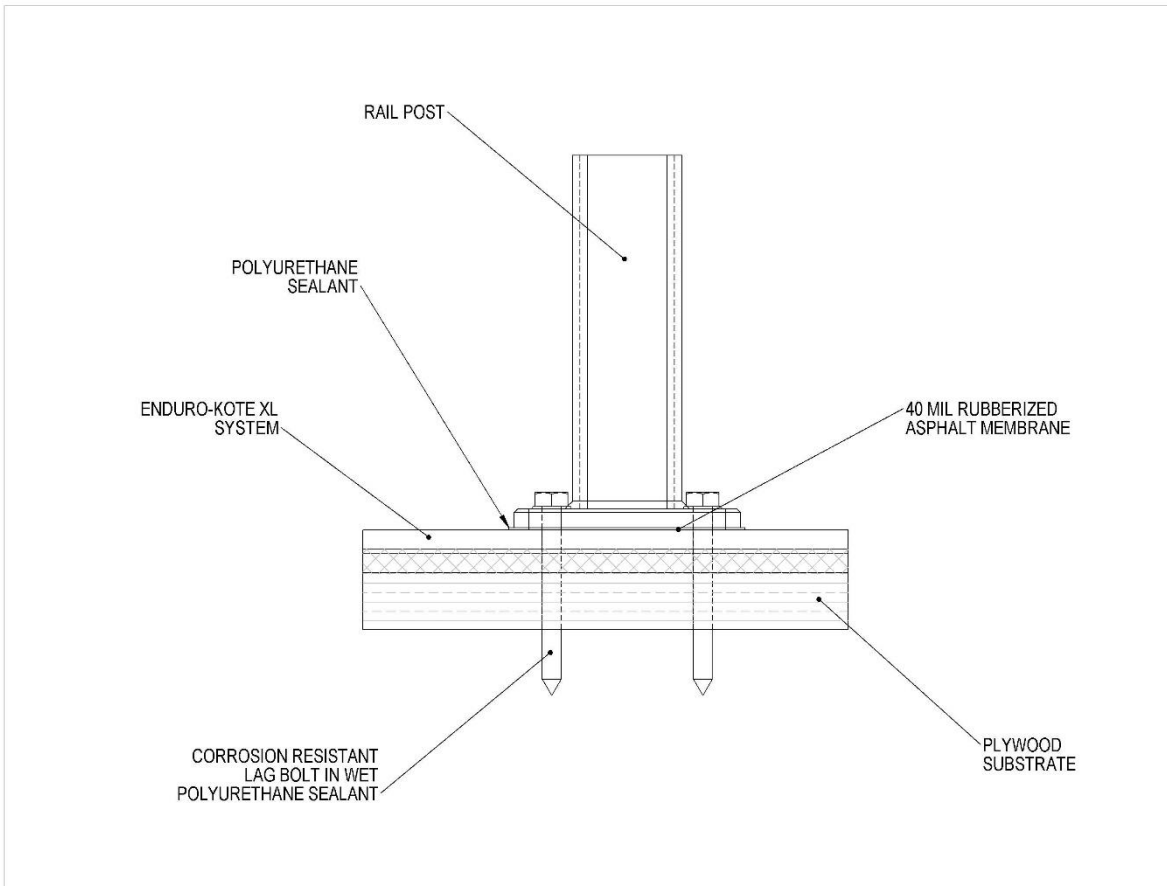

Corporate Office: 1133 N Patt Street, Anaheim, California 92801 - Phone: (714) 526-5898 - Fax (714) 526-6511

Florida Office: 8050 NW 66th Street, Miami, Florida 33166 - Phone: (305) 591-8303 - Fax (941) 378-9438

Toll Free: (877) 809-0781 - Email: info@endurokote.com - Website: www.endurokote.com

Enduro-Kote

REVISED NOVEMBER 2007



ENDURO-KOTE XL

SCUPPER DETAIL

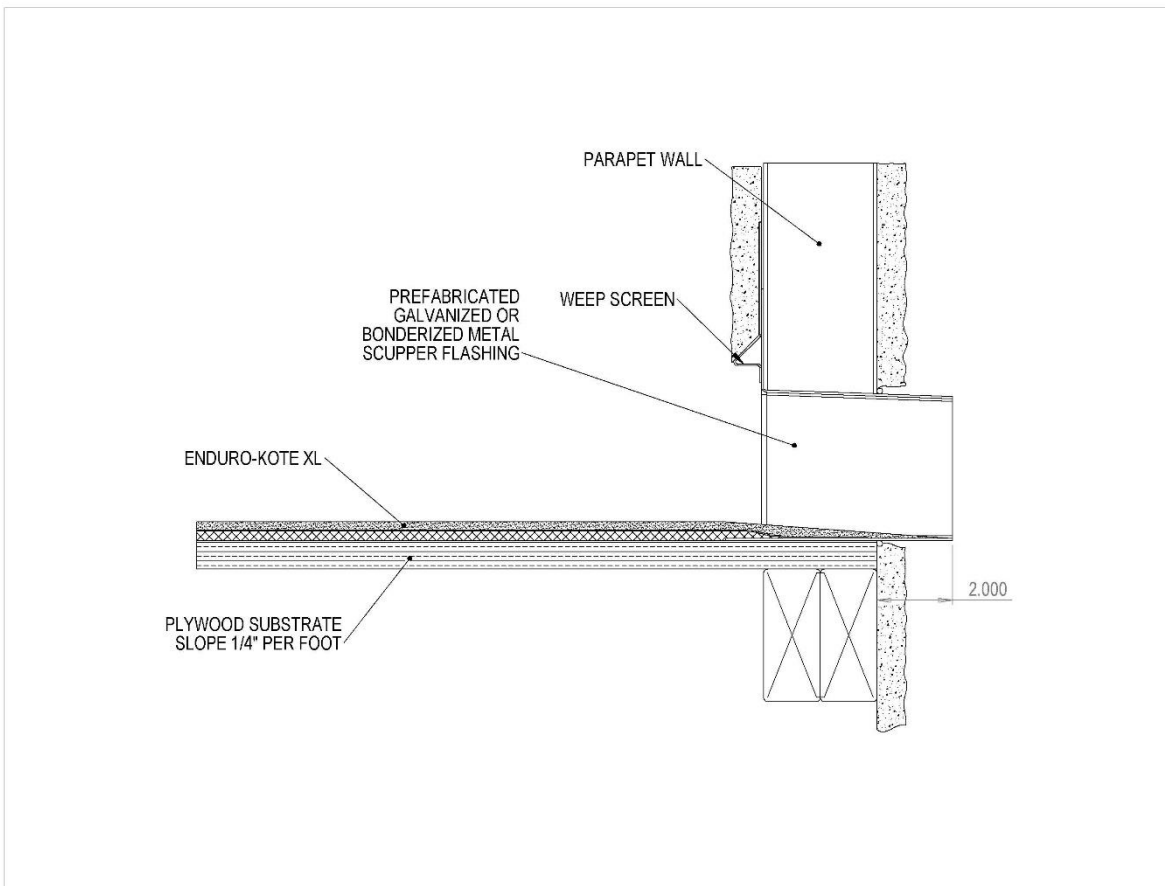

Corporate Office: 1133 N Patt Street, Anaheim, California 92801 - Phone: (714) 526-5898 - Fax (714) 526-6511

Florida Office: 8050 NW 66th Street, Miami, Florida 33166 - Phone: (305) 591-8303 - Fax (941) 378-9438

Toll Free: (877) 809-0781 - Email: info@endurokote.com - Website: www.endurokote.com

Enduro-Kote

REVISED NOVEMBER 2007



ENDURO-KOTE XL

SILL PAN DETAIL

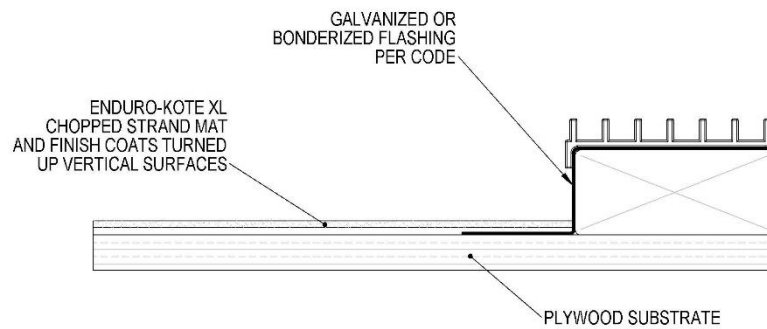

Corporate Office: 1133 N Patt Street, Anaheim, California 92801 - Phone: (714) 526-5898 – Fax (714) 526-6511

Florida Office: 8050 NW 66th Street, Miami, Florida 33166 - Phone: (305) 591-8303 – Fax (941) 378-9438

Toll Free: (877) 809-0781 - Email: info@endurokote.com - Website: www.endurokote.com

Enduro-Kote

REVISED NOVEMBER 2007